

# 亨通其心 龙行天下

Heron , Reputation In The World



地址：广州市从化区太平镇新一路 63 号  
邮编：510990  
电话：020-87813325 87819588 87815075  
传真：020-87813346  
邮箱：info@heronwelder.com  
www.heronwelder.com

Add : No.63 Xin Yi Road, Taiping Town, Conghua District ,  
Guangzhou China Post Code : 510990  
TEL : 020-87813325 87819588 87815075  
FAX : 020-87813346  
E-mail: info@heronwelder.com  
www.heronwelder.com

24 小时服务热线：**400-088-3325**  
24 hours service hotline:



亨龙微信公众号  
Heron Public  
Wechat Number



# HERON

金属连接智能装备解决方案  
Metal connection solution

广州亨龙智能装备股份有限公司  
Heron Intelligent Equipment Co.,Ltd

2022 年修订版



- 亨龙 1991 年始创于广州
- 员工 300 余人，建筑面积 54,000m<sup>2</sup>
- 专注于金属连接工艺，自主研发核心技术
- 拥有全系列电阻焊，无铆钉铆接及平面自冲铆工艺及设备
- 服务于汽车车身制造、汽车零部件制造、低压电气制造、压缩机制造、家电制造、五金制造、电机制造等行业
- 拥有二十多家世界五百强高端客户群体
- 客户遍及欧美等十多个国家和地区



- Heron was founded in 1991 in Guangzhou.
- More than 300 employees and and plant size 54000 square meter.
- Focus on metal joining process, independent research and development of core technology.
- A full range of resistance welding, clinch and FSPR technology and equipment.
- Main Application Industries:Automotive manufacturing, automobile parts manufacturing, low-voltage electrical manufacturing, compressor manufacturing, household appliances and hardware manufacturing, motor manufacturing and other industries.
- With more than 20 high-end customers of the world's top 500
- Customers in more than 10 countries and regions, including Europe and the USA.

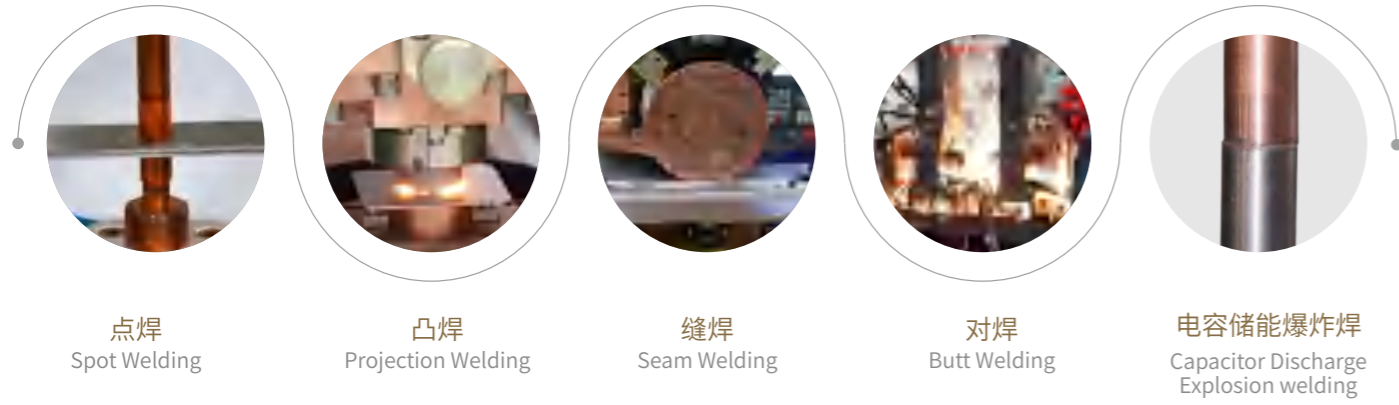

点焊 Spot Welding      凸焊 Projection Welding      缝焊 Seam Welding      对焊 Butt Welding      电容储能爆炸焊 Capacitor Discharge Explosion welding

## 国际先进水平的金属连接技术

一种无需焊接材料的金属连接方式

International advanced level of metal connection technology

A metal connection method that does not require welding materials

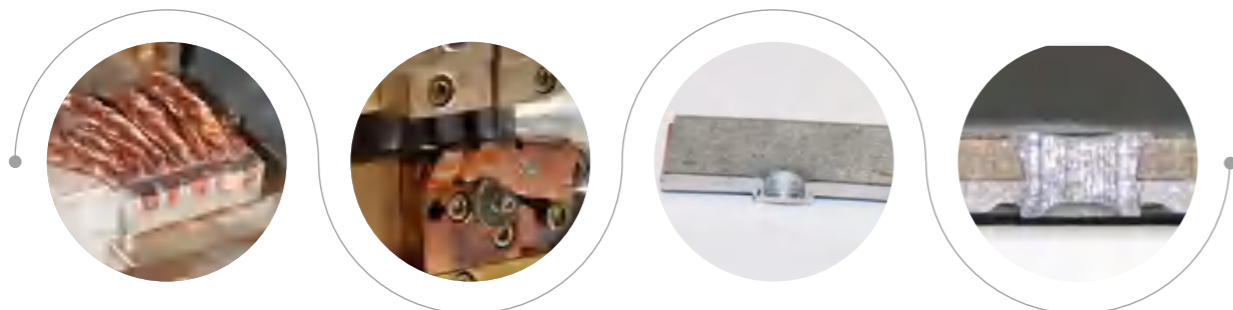

电阻扩散焊 Resistance Diffusion Welding      电阻钎焊 Resistance Brazing      无铆钉铆接 Tog-L-Loc      平面自冲铆 Flush Self-Piercing Riveting

国际先进水平的MFDC 电阻焊技术及全系列的中频点凸焊机

The international advanced MFDC resistance welding technology and the full range of MFDC spot and projection welding machines

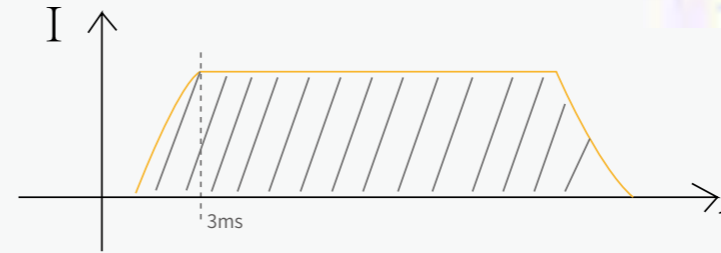

中频直流放电曲线  
Medium Frequency DC Discharge Curve

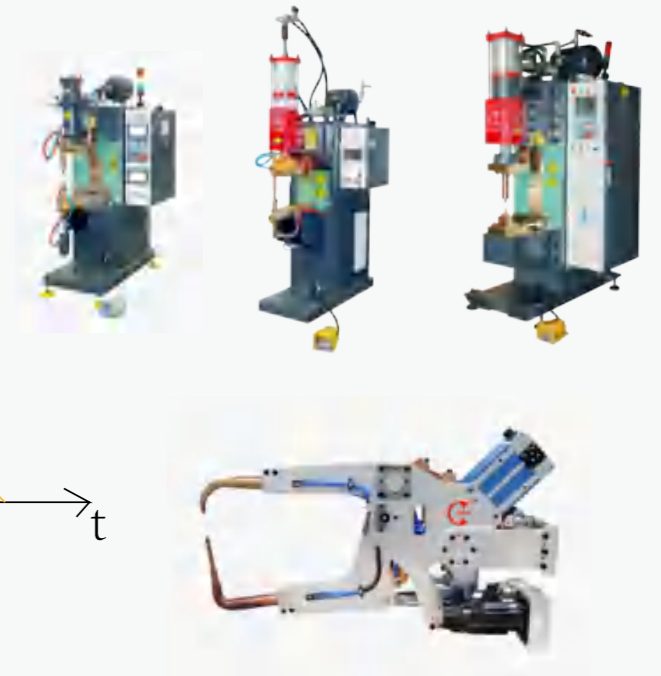

国际先进水平的中压电容储能电阻焊技术及全系列的中压电容点凸焊机

International advanced medium voltage capacitor discharge resistance welding technology and a full range of medium voltage capacitor spot & projection welding machines

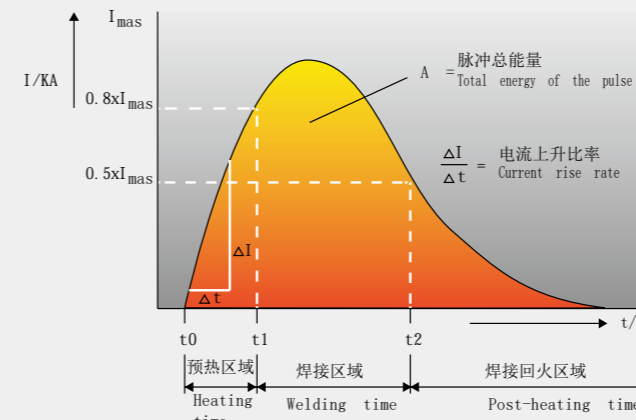

电容储能放电曲线  
Capacitor Energy Storage Discharge Curve



BTM 无铆钉铆接系统  
BTM Tog-L-Loc system

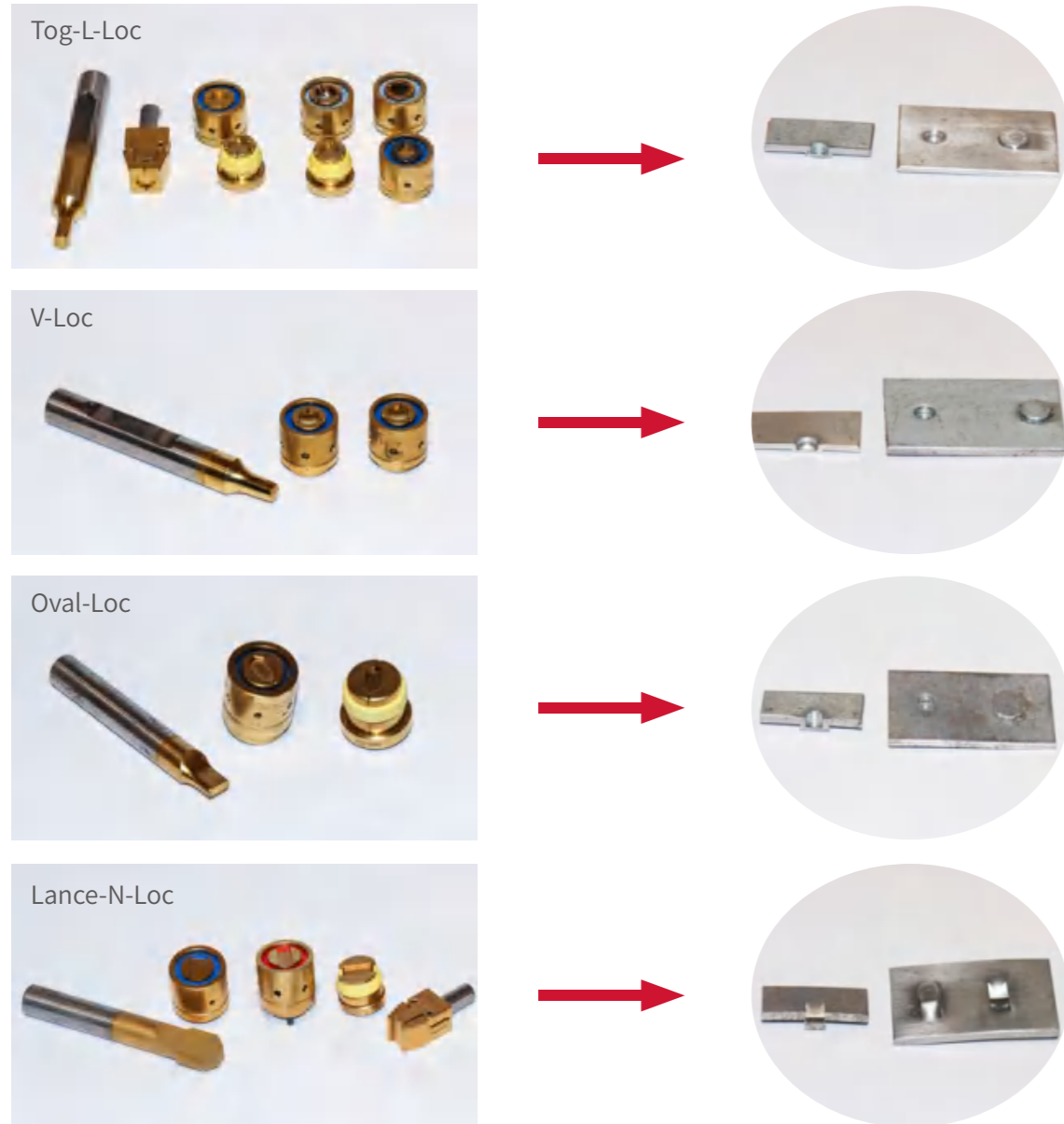

工作原理  
Working principle

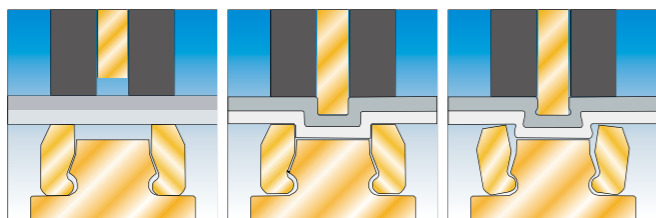

FSPR 平面自冲铆系统  
Flush Self-Piercing Riveting



工作原理  
Working principle

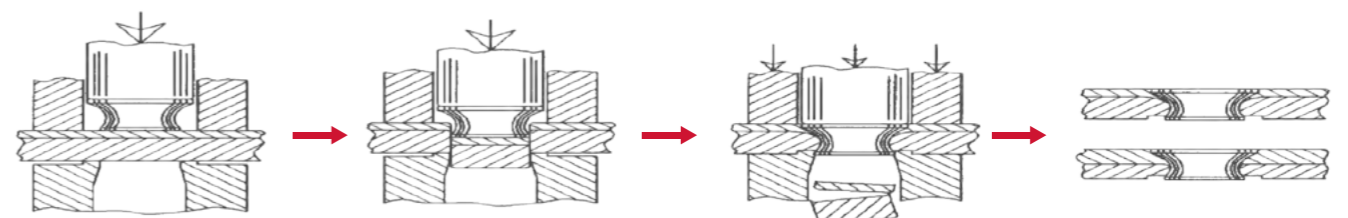

### C 型伺服机器人焊钳

C Type Robotic Welding Gun With Servo Actuator



DB6-110-C22110

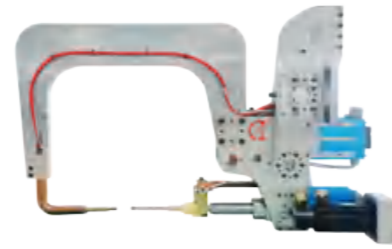

DB6-110-C22122D

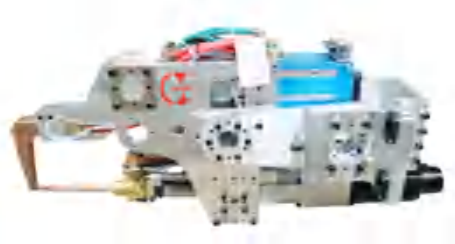

DB6-110-C22143



DB6-110-C22152

型号 Model No	DB6-110-C22110	DB6-110-C22122D	DB6-110-C22143	DB6-110-C22152
总重量 (Kg) Gross Weight (Kg)	101	143.1	86	110
变压器额定容量 (KVA) Rated Capacity Of Transformer (KVA)	110	110	110	110
喉深 * 喉宽 (mm) Arm Size(mm)	176*243	575*668	165*317	185*423
总长 * 总高 * 总宽 (mm) L*H*W (mm)	1180*622*357	1456*877*392	1209*523*653	1316*520*371
最大短路电流 (KA) Max. Short Circuit Current (KA)	22	22	22	22
最大电极开口 (mm) Max Stroke (mm)	115	205	125	176
最大电极压力 (N) Max Electrode Force (N)	5000	5000	5000	5000
电极挠度 (mm) Arm Deflection (mm)	≤ 1.5	≤ 1.5	≤ 1.5	≤ 1.5
电极偏心量 (mm) Electrode Off Centre (mm)	≤ 0.5	≤ 0.5	≤ 0.5	≤ 0.5
重心相对位置 (X/Y/Z,cm) Center OF Gravity (X/Y/Z,cm)	10.1/0.6/44.2	32.4/1.7/37.1	0.8/2.6/37	7.4/0.6/4.8
电极臂材质 Arm Material	铜棒 Copper Bar	铜棒 Copper Bar	铜板 Copper	铜棒 Copper Bar
机器人联接方向 Connecting Way With Robot	上、下、左、右、后 Top, Bottom, Left, Right, Rear			
伺服电机 Servo Motor	适合任何机器人厂家及 diakont 一体式 Apply to all Robot Brands and Can be integrated with diakont			

### X 型伺服机器人焊钳

X Type Robotic Welding Gun With Servo Actuator



DB6-110-X22116

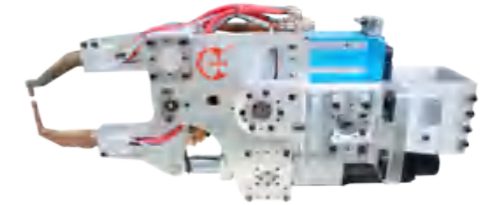

DB6-110-X22142



DB6-110-X22181

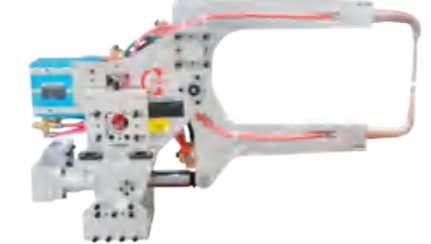

DB6-110-X22203D

型号 Model No	DB6-110-X22116	DB6-110-X22142	DB6-110-X22181	DB6-110-X22203D
总重量 (Kg) Gross Weight (Kg)	123	107	107	121
变压器额定容量 (KVA) Rated Capacity Of Transformer (KVA)	110	110	110	110
喉深 * 喉宽 (mm) Arm Size(mm)	441*849	161*378	264*506	281*609
总长 * 总高 * 总宽 (mm) L*H*W (mm)	1790*775*355	1196*828*362	1403*630*357	1273*724*520
最大短路电流 (KA) Max. Short Circuit Current (KA)	22	22	22	22
最大电极开口 (mm) Max Stroke (mm)	297	164	212	252
最大电极压力 (N) Max Electrode Force (N)	5000	5000	5000	5000
电极挠度 (mm) Arm Deflection (mm)	≤ 1.5	≤ 1.5	≤ 1.5	≤ 1.5
电极偏心量 (mm) Electrode Off Centre (mm)	≤ 0.5	≤ 0.5	≤ 0.5	≤ 0.5
重心相对位置 (X/Y/Z,cm) Center OF Gravity (X/Y/Z,cm)	0.5/10.3/41	0.7/1.9/57.8	4.2/-0.5/40.3	8.6/1.0/41.4
电极臂材质 Arm Material	铜棒 Copper Bar	铜棒 Copper Bar	铜棒 Copper Bar	铜棒 Copper Bar
机器人联接方向 Connecting Way With Robot	上、下、左、右、后 Top, Bottom, Left, Right, Rear			
伺服电机 Servo Motor	适合任何机器人厂家及 diakont 一体式 Apply to all Robot Brands and Can be integrated with diakont			

### H 系列 X 型焊钳

H Series X Type Integration Hanging Manual Welding Gun

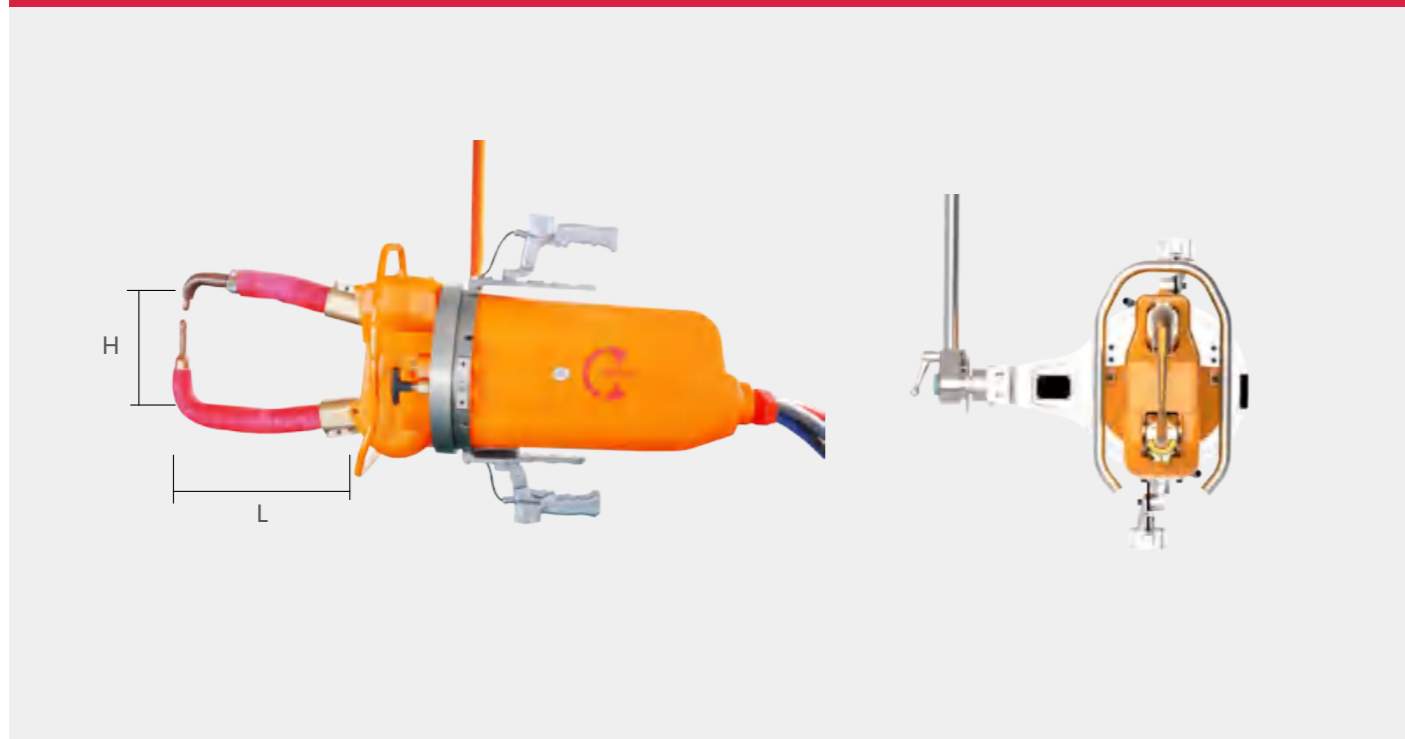

	序号 Item	变压器 Transformer	气缸直径 Cylinder diameter (mm)	动力臂长 Dynamic arm length (mm)	气缸行程 Stroke(mm) 辅助 / 工作 / 预留 Assist/Weld/Back up	气缸 节数 Cylinder number	次级电压 Secondary voltage (V)	焊接压力范 围 Welding force (Kg) 0.5MPa	次级短路电 流 Secondary short circuit current (KA)	总重量 Total Weight (Kg)	L (mm)	H (mm)
X160	1	55KVA MFDC	Φ80	152	35/10/10	3-5	8.9	200-500	15	75-95	标准 喉深 Standard throat	标准 臂间距 Standard arm gap
	2	110KVA MFDC				4-6						
	3	40KVA AC	Φ80	152	35/10/10	4-6	5	200-500	14	90-110		
	4	65KVA AC				4-6	9.7	200-500	18	90-110		
X230	1	55KVA MFDC	Φ80	178	35/10/10	3-5	8.9	200-500	15	75-95	标准 喉深 Standard throat	标准 臂间距 Standard arm gap
	2	110KVA MFDC				4-6						
	3	40KVA AC	Φ80	178	35/10/10	4-6	5	200-500	14	90-110		
	4	65KVA AC				4-6	9.7	200-500	18	90-110		

### H 系列 C 型焊钳

H Series C Type Integration Hanging Manual Welding Gun

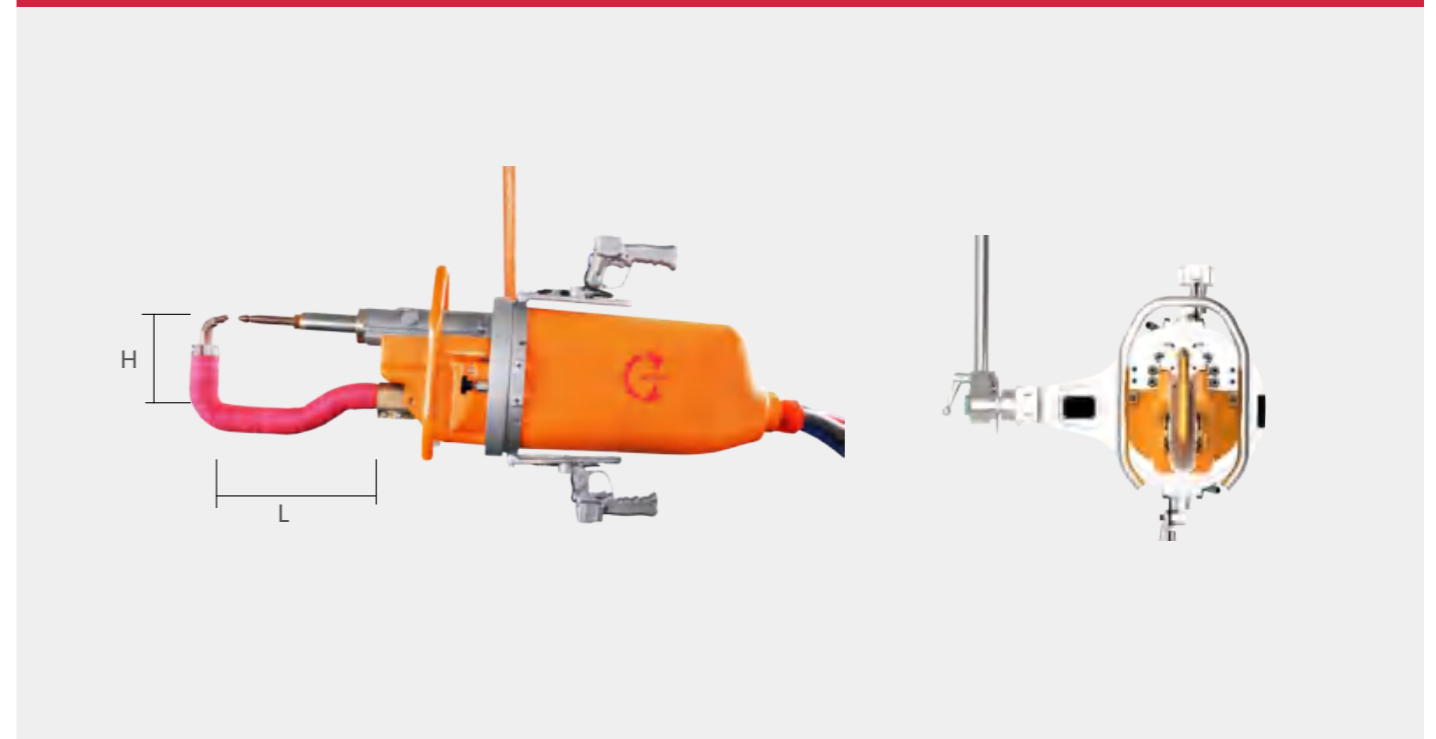

	序号 Item	变压器 Transformer	气缸直径 Cylinder diameter (mm)	气缸行程 Stroke(mm) 辅助 / 工作 / 预留 Assist/Weld/Back up	气缸 节数 Cylinder number	次级电压 Secondary voltage (V)	焊接压力范 围 Welding force (Kg) 0.5MPa	次级短路电 流 Secondary short circuit current (KA)	总重量 Total Weight (Kg)	L (mm)	H (mm)
C150	1	55KVA MFDC	Φ80	45/20/20 90/20/20 130/20/20	2	8.9	400	15	75-95	标准 喉深 Standard throat	标准 臂间距 Standard arm gap
	2	110KVA MFDC			2						
	3	40KVA AC	Φ80	45/20/20 90/20/20 130/20/20	2	5	400	14	90-110		
	4	65KVA AC			2	9.7	400	18	90-110		

注：参数和机器图片仅供参考，在应用条件改变时，参数会有所不同。最终解释权归亨龙公司所有。  
Note: The parameters and equipment pictures are only for reference. When the application conditions changed, the parameters will be different. The final explanation right belongs to Heron company.

### L3 系列 X 型焊钳

L3 Series X Type Integration Hanging Manual Welding Gun



	序号 Item	变压器 Transformer (KVA)	气缸直径 Cylinder diameter (mm)	动力臂长 Dynamic arm length (mm)	气缸行程 Stroke(mm) 辅助 / 工作 / 预留 Assist/Weld/Back up	次级电压 Secondary voltage (V)	标配喉深 Standard throat (mm)	焊接压力范围 Welding force (dN)	次级短路电 流 Secondary short circuit current (KA)	L (mm)	H (mm)
L31	1	55(MFDC)	Φ100	210	25/50	8.9	300	180-450	18	200 ~ 600	40 ~ 130
	2	32(AC)	Φ100	210	25/50	5.6	300	180-450	12		
L32	1	55(MFDC)	Φ100	210	25/50	8.9	300	180-450	18	200 ~ 600	160 ~ 330
	2	32(AC)	Φ100	210	25/50	5.6	300	180-450	12		

注：参数和机器图片仅供参考，在应用条件改变时，参数会有所不同。最终解释权归亨龙公司所有。  
Note: The parameters and equipment pictures are only for reference. When the application conditions changed, the parameters will be different. The final explanation right belongs to Heron company.

### L3 系列 C 型焊钳

L3 Series C Type Integration Hanging Manual Welding Gun



	序号 Item	变压器 Transformer (KVA)	气缸直径 Cylinder diameter (mm)	气缸行程 Stroke(mm) 辅助 / 工作 / 预留 Assist/Weld/Back up	次级电压 Secondary voltage (V)	标配喉深 Standard throat (mm)	焊接压力范围 Welding force (dN)	次级短路电 流 Secondary short circuit current (KA)	L (mm)	H (mm)
L31 L32	1	55(MFDC)	Φ80	20/80 20/100	8.9	250	250	18	200 ~ 350	40 ~ 350
	2	32(AC)	Φ80	20/80 20/100	5.6	250	250	12		
L33	1	55(MFDC)	Φ80	20/130	8.9	250	250	18	200 ~ 350	40 ~ 350
	2	32(AC)	Φ80 Φ100	20/130	5.6	250	250	12		

注：参数和机器图片仅供参考，在应用条件改变时，参数会有所不同。最终解释权归亨龙公司所有。  
Note: The parameters and equipment pictures are only for reference. When the application conditions changed, the parameters will be different. The final explanation right belongs to Heron company.

### L2 系列 X 型焊钳

L2 Series X Type Integration Hanging Manual Welding Gun

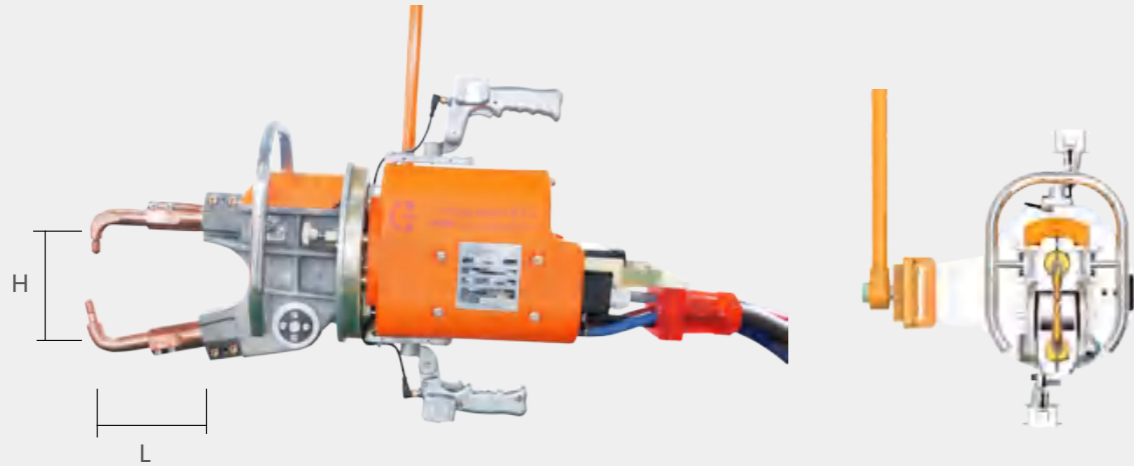

	序号 Item	变压器 Transformer (KVA)	气缸直径 Cylinder diameter (mm)	动力臂长 Dynamic arm length (mm)	气缸行程 Stroke(mm) 辅助 / 工作 / 预留 Assist/Weld/Back up	次级电压 Secondary voltage (V)	标配喉深 Standard throat (mm)	焊接压力范围 Welding force (dN)	次级短路电 流 Secondary short circuit current (KA)	L (mm)	H (mm)
L21	1	55(MFDC)	Φ100	210	25/50	10	300	450	18	200 ~ 750	40 ~ 130
	3	110(MFDC)	Φ100	210	25/50	10.4	300	370	20		
L22	1	55(MFDC)	Φ100	210	25/50	10	300	450	18	200 ~ 750	155 ~ 330
	3	110(MFDC)	Φ100	210	25/50	10.4	300	370	20		

注：参数和机器图片仅供参考，在应用条件改变时，参数会有所不同。最终解释权归亨龙公司所有。  
Note: The parameters and equipment pictures are only for reference. When the application conditions changed, the parameters will be different. The final explanation right belongs to Heron company.

### L2 系列 C 型焊钳

L2 Series C Type Integration Hanging Manual Welding Gun



	序号 Item	变压器 Transformer (KVA)	气缸直径 Cylinder diameter (mm)	气缸行程 Stroke(mm) 辅助 / 工作 / 预留 Assist/Weld/Back up	次级电压 Secondary voltage (V)	标配喉深 Standard throat (mm)	焊接压力范围 Welding force (dN)	次级短路电 流 Secondary short circuit current (KA)	L (mm)	H (mm)
L21 L22	1	55(MFDC)	Φ80 Φ100	20/60 20/80	10	300	390	18	200 ~ 350	40 ~ 350
	2	32(AC)	Φ80 Φ100	20/60 20/80	10.4	300	390	20		
L23 L24	1	55(MFDC)	Φ80 Φ100	20/110	10	300	390	18	250 ~ 400	40 ~ 350
	2	110(MFDC)	Φ80 Φ100	20/130	10.4	300	390	20		

注：参数和机器图片仅供参考，在应用条件改变时，参数会有所不同。最终解释权归亨龙公司所有。  
Note: The parameters and equipment pictures are only for reference. When the application conditions changed, the parameters will be different. The final explanation right belongs to Heron company.

E/L 系列中频焊机  
E/L Series MFDC Welder

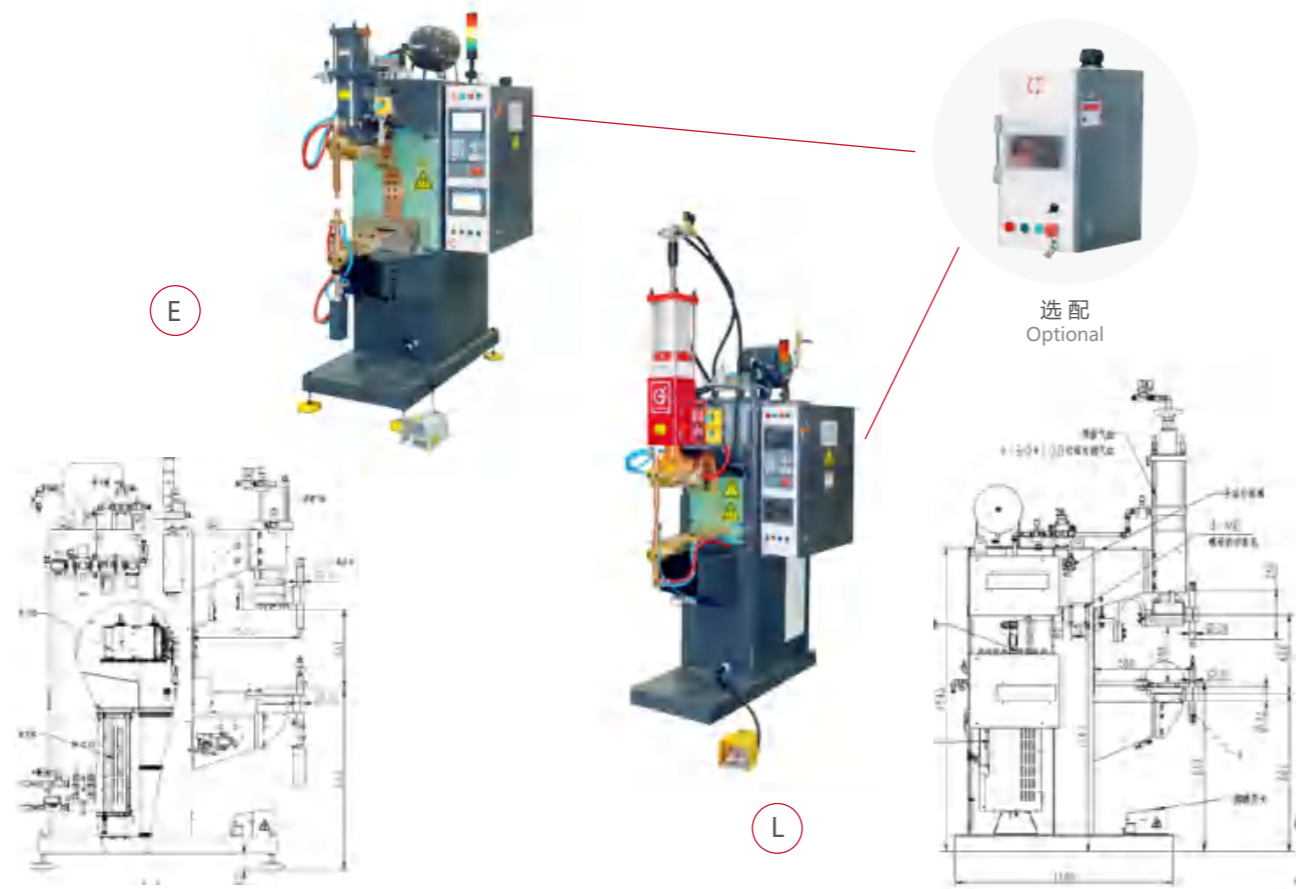

名称 Name	序号 Item	图号 Model	图号 Model	备注 Remarks
L系列中频焊机 L Series MFDC Welder	1	DB-110-T4L01	DB-110-T4E03	
	2	DB-165-T4L01	DB-165-T4E03	
	3	DB-220-T4L01	DB-220-T4E03	
	4	DB-250-T4L01	DB-250-T4E03	
	5	DB-330-T4L01	DB-330-T4E03	
	6	DB-440-T3L01	DB-440-T4E03	

技术参数  
Specifications

焊机型号 Model #		DB-110	DB-165	DB-220	DB-250	DB-330	DB-440
额定容量 Rated Capacity	KVA	110	165	220	250	330	440
外接电源 Power Supply	V/Φ/Hz	380V/3Φ/50Hz					
最大初级电流 Max. Primary Current	A	100	120	150	150	240	350
初级电缆规格 Primary Cable	MM <sup>2</sup>	3*25+2*16	3*35+2*16	3*35+2*16	3*35+2*16	3*50+2*16	3*50+2*16
最大短路电流 Max. Short Circuit Current	KA	24	30	40	45	58	59.9
额定负载持续率 Rated Duty Cycle	%	20	20	20	20	20	20
次级电压 Secondary Empty Voltage	V	10.4	13	10.4	12.5	13	10.4
焊接气缸规格 Welding Cylinder Size	Φ*L	Φ125/100	Φ140*100	Φ140*100	Φ200*100	Φ200*100	Φ200*100
最大工作压力 Max. Working Pressure	N	6000	7500	7500	10000	15000	15000
喉深 Throat Depth	MM	500	500	500	500	500	500
臂间距 Arm Gap	MM	405	405	405	405	405	405
外形尺寸 Dimensions	H(MM)	2154	2154	2154	2154	2154	2154
	L(MM)	1280	1280	1280	1280	1280	1280
	W(MM)	872	872	872	872	972	972

注：参数和机器图片仅供参考，在应用条件改变时，参数会有所不同。最终解释权归亨龙公司所有。  
Note: The parameters and equipment pictures are only for reference. When the application conditions changed, the parameters will be different. The final explanation right belongs to Heron company.

H 系列中频焊机  
H Series MFDC Welder

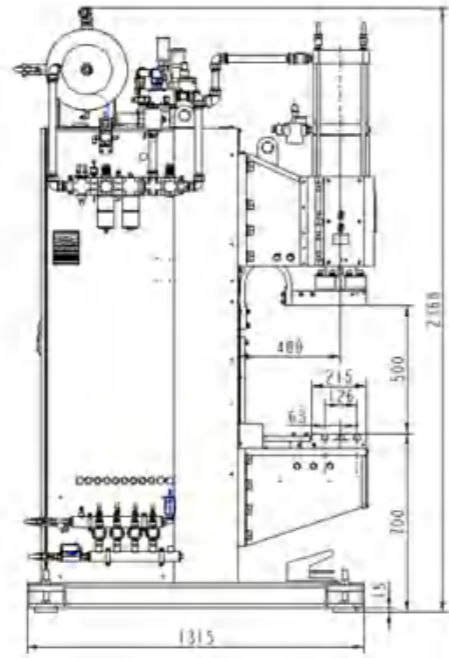

名称 Name	序号 Item	图号 Model	备注 Remarks
H系列中频焊机 H Series MFDC Welder	1	DB-110-T3H00	
	2	DB-165-T3H00	
	3	DB-220-T3H00	
	4	DB-250-T3H00	
	5	DB-330-T3H00	
	6	DB-500-T3H00	
	7	DB-440-T3H00	
	8	DB-660-T3H00	
	9	DB-750-T3H00	
	10	DB-880-T3H00	

技术参数  
Specifications

焊机型号 Model #		DB-110	DB-165	DB-220	DB-250	DB-330	DB-440	DB-500	DB-660	DB-750	DB-880
额定容量 Rated Capacity	KVA	110	165	220	250	330	440	500	660	750	880
外接电源 Power Supply	V/Φ/Hz	380V/3Φ/50Hz									
最大初级电流 Max. Primary Current	A	100	120	150	150	240	350	339	500	508	700
初级电缆规格 Primary Cable	MM <sup>2</sup>	3*25+2*16	3*35+2*16	3*35+2*16	3*35+2*16	3*50+2*16	3*50+2*16	3*70+2*16	3*70+2*16	3*90+16+25	3*90+2*16
最大短路电流 Max. Short Circuit Current	KA	24	30	40	45	58	59.9	70	85	90	110
额定负载持续率 Rated Duty Cycle	%	20	20	20	20	20	20	20	20	20	20
次级电压 Secondary Empty Voltage	V	10.4	13	10.4	12.5	13	10.4	12.5	10.4	12.5	10.4
焊接气缸规格 Welding Cylinder Size	Φ*L	Φ125*150	Φ140*150	Φ160*150	Φ200*150	Φ200*150	Φ200*150	Φ250*150	Φ250*150	Φ300*150	Φ300*150
最大工作压力 Max. Working Pressure	N	6000	7000	10000	10000	15000	15000	24000	24000	35000	35000
喉深 Throat Depth	MM	400	400	400	400	400	400	400	400	400	400
臂间距 Arm Gap	MM	500	500	500	500	500	500	500	500	500	500
外形尺寸 Dimensions	H(MM)	2435	2435	2435	2435	2435	2435	2435	2435	2435	2435
	L(MM)	1315	1315	1315	1315	1315	1315	1315	1315	1315	1315
	W(MM)	1021	1021	1021	1021	1021	1251	1251	1251	1251	1251

注：参数和机器图片仅供参考，在应用条件改变时，参数会有所不同。最终解释权归亨龙公司所有。  
Note: The parameters and equipment pictures are only for reference. When the application conditions changed, the parameters will be different. The final explanation right belongs to Heron company.

L 系列储能焊机  
L Series CD Welder

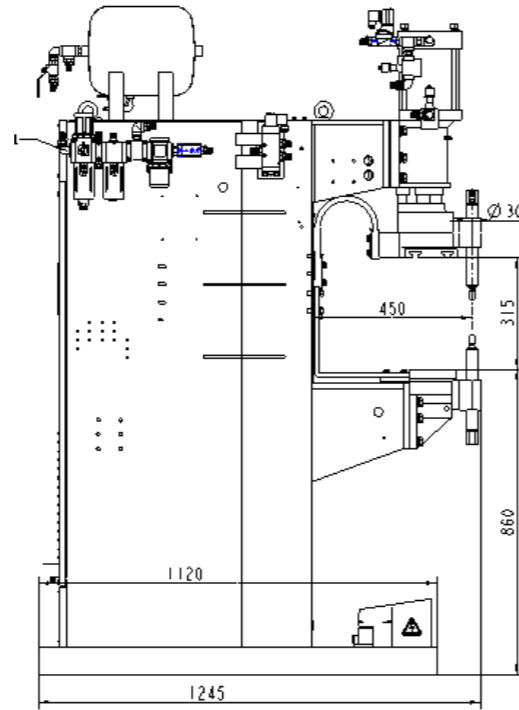

名称 Name	序号 Item	图号 Model	备注 Remarks
L系列储能焊机 L Series CD Welder	1	DR-3000-211T3L00	
	2	DR-4500-211T3L00	
	3	DR-6000-211T3L00	

技术参数  
Specifications

焊机型号 Model #		DR-3000	DR-4500	DR-6000
电容容量 Volume of capacitor	μf	30000	45000	60000
额定容量 Rated Capacity	KVA	5	10	15
外接电源 Power Supply	V/Φ/Hz	380/3/50		
最大初级电流 Max. Primary Current	A	23	26	40
初级电缆规格 Primary Cable	MM <sup>2</sup>	16	16	16
最大短路电流 Max. Short Circuit Current	KA	28	38	58
额定负载持续率 Rated Duty Cycle	%	50	50	50
次级电压 Secondary Empty Voltage	V	10	10/11.4	11/12
焊接气缸规格 Welding Cylinder Size	Φ*L	Φ100*60	Φ160*80	Φ160*80
最大工作压力 Max. Working Pressure	N	3900	7500	10000
喉深 Throat Depth	MM	353	427	427
臂间距 Arm Gap	MM	220	300	300
外形尺寸 Dimensions	H(MM)	1459	1885	1885
	L(MM)	1070	1239	1239
	W(MM)	664	754	754

注：参数和机器图片仅供参考，在应用条件改变时，参数会有所不同。最终解释权归亨龙公司所有。  
Note: The parameters and equipment pictures are only for reference. When the application conditions changed, the parameters will be different. The final explanation right belongs to Heron company.

H 系列储能焊机  
H Series CD Welder

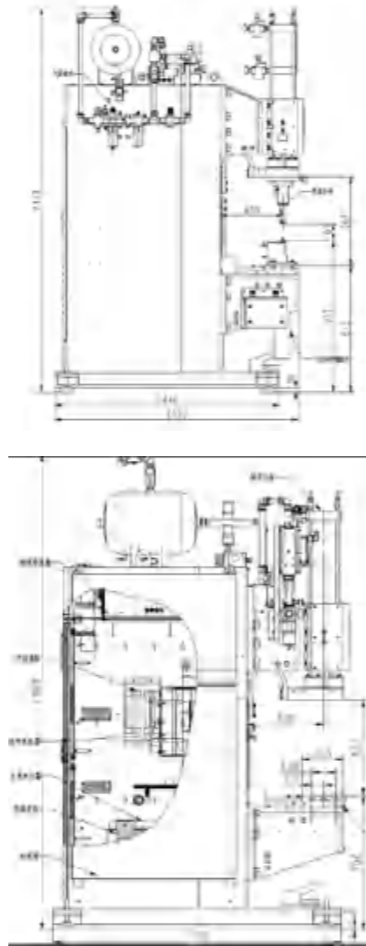

名称 Name	序号 Item	图号 Model	备注 Remarks
H系列中频焊机 H Series CD Welder	1	DR-10000-T3H00	
	2	DR-15000T3H00	
	3	DR-20000-T3H00	
	4	DR-25000-T3H00	
	5	DR-30000-T3H00	
	6	DR-35000-T3H00	
	7	DR-40000-T3H00	

技术参数  
Specifications

焊机型号 Model #		DR-10000	DR-15000	DR-20000	DR-25000	DR-30000	DR-35000	DR-40000
电容容量 Volume of capacitor	μf	20000	30000	40000	50000	60000	70000	90000
额定容量 Rated Capacity	KVA	40	60	100	100	100	100	100
外接电源 Power Supply	V/Φ/Hz	380/3/50						
最大初级电流 Max. Primary Current	A	79	79	79	132	132	158	158
初级电缆规格 Primary Cable	MM <sup>2</sup>	25	25	50	50	50	50	50
最大短路电流 Max. Short Circuit Current	KA	80	100	130	140	140	175	230
额定负载持续率 Rated Duty Cycle	%	50	50	50	50	50	50	50
次级电压 Secondary Empty Voltage	V	11/13	15/18	19/23	20/26.6	20/26.6	27/30	27/30
焊接气缸规格 Welding Cylinder Size	Φ*L	Φ140*150	Φ160*150	Φ200*150	Φ200*150	Φ250*150	Φ250*150	Φ300*150
最大工作压力 Max. Working Pressure	N	7500	10000	15000	15000	24000	24000	35000
喉深 Throat Depth	MM	400	400	400	400	400	400	400
臂间距 Arm Gap	MM	400	400	400	400	400	400	400
外形尺寸 Dimensions	H(MM)	2303	2437	2437	2437	2437	2437	2437
	L(MM)	1495	1500	1500	1500	1500	1500	1500
	W(MM)	1069	1451	1451	1451	1451	1451	1451

注：参数和机器图片仅供参考，在应用条件改变时，参数会有所不同。最终解释权归亨龙公司所有。  
Note: The parameters and equipment pictures are only for reference. When the application conditions changed, the parameters will be different. The final explanation right belongs to Heron company.

双头中频焊机  
Double Head MFDC Welder



焊机系列 Series	焊机基本信息 Basic Information	允许变化模块 Allowed Changes Module	备注 Remarks
双头中频焊机, 单电源 (汽车行业) Double Head MFDC Welder Single power supply	1、菱形导轨气缸; 2、喉深:400mm(气缸中心); 3、电极瓦之间:500/600mm; 4、功率可选:165KVA,220,250,330,440,500,660,880; 5、水流量开关(易福门); 6、气路元件品牌:FESTO/SMC; 7、控制器:802; 8、电极瓦:T型; 9、比例阀; 10、气包:30L	可选择圆轴气缸(功率:165KVA/220KVA,330KVA):可选直径125,140,160,200; 直线导轨(功率:(功率:165KVA/220KVA,330KVA):可选直径125,140,160,200; 菱形导轨气缸:Ø125(单双倍力),Ø140,Ø160(单双倍力),Ø200(单双倍力),Ø250(单双倍力),Ø300;  Optional round shaft cylinder (power: 165KVA/220KVA,330KVA):optional diameter 125,140,160,200. Linear guide (power: (power: 165KVA/220KVA,330KVA):optional diameter 125,140,160,200. Diamond guide cylinder: Ø125(single and double force),Ø140,Ø160(single and double force),Ø200(single and double force),Ø250(single and double force),Ø300.	
		喉深(600)、臂间距变化(尺寸根据需要定制) Throat depth (600), arm spacing variation (size customized as needed)	
		气动元件可选品牌:SMC/FESTO Pneumatic components optional brand: SMC / FESTO	定型定制 Customization
		双手启动开关、护栏、安全光栅、螺母、螺柱、排焊电极组件等标准化定型模块 Standardized stereotyped modules such as two-hand start switch, guardrail, safety grating, nuts, studs, row welding electrode assembly, etc.	定型定制 Customization

双头储能焊机  
Double Head CD Welder



焊机系列 Series	焊机基本信息 Basic Information	允许变化模块 Allowed Changes Module	备注 Remarks
双头储能焊机, 单电源 (汽车行业) Double Head CD Welder Single power supply	1、菱形导轨气缸; 2、喉深:400mm(气缸中心); 3、电极瓦之间:500/600mm; 4、功率可选:10000J/15000J/20000J/25000J/30000J/35000J/40000J; 5、水流量开关(易福门); 6、气路元件品牌:FESTO/SMC; 7、控制器:211; 8、电极瓦:T型; 9、比例阀; 10、气包:30L	可选择圆轴气缸(功率:10000J/20000J/15000J):可选直径125,140,160,200; 直线导轨(功率:10000J/20000J/15000J):可选直径125,140,160,200; 菱形导轨气缸:Ø125(单双倍力),Ø140,Ø160(单双倍力),Ø200(单双倍力),Ø250(单双倍力),Ø300;  Optional round shaft cylinder (power:10000J/20000J/15000J):optional diameter 125,140,160,200. Linear guide (power: 10000J/20000J/15000J): optional diameters 125,140,160,200. Diamond guide cylinder: Ø125(single and double power),Ø140,Ø160(single and double power),Ø200(single and double power),Ø250(single and double power),Ø300.	
		喉深(600)、臂间距变化(尺寸根据需要定制) Throat depth (600), arm spacing variation (size customized as needed)	
		气动元件可选品牌:SMC/FESTO Pneumatic components optional brand: SMC / FESTO	定型定制 Customization
		双手启动开关、护栏、安全光栅、螺母、螺柱、排焊电极组件等标准化定型模块 Standardized stereotyped modules such as two-hand start switch, guardrail, safety grating, nuts, studs, row welding electrode assembly, etc.	定型定制 Customization

台式点凸焊机  
Bench Spot/Press Welder



25/55KVA 台式中频点凸焊机  
25/55KVA MFDC Bench Spot/ Press Welder



25/55/110/165/220KVA 台式中频点凸焊机  
25/55/110/165/220KVA MFDC Bench Spot/ Press Welder



500/1500J 台式储能点凸焊机  
500/1500J CD Bench Spot/ Press Welder



500/1500J 双头台式储能点凸焊机  
500/1500J CD Double Heads Bench Spot/ Press Welder

技术参数  
Specifications

焊机型号 Model #		DB-25-***1**	DB-55-***1**	DB-110-***1**	DB-165-***1**	DB-220-***1**	DR-500-**	DR-1500-**
电容容量 Volume of capacitor	μf	/	/	/	/	/	5000	15000
额定容量 Rated Capacity	KVA	25	55	110	165	220	2	3
外接电源 Power Supply	V/Φ/Hz	380V/3/50Hz					220/1/50	
最大初级电流 Max. Primary Current	A	17	37	75	112	149	9	14
初级电缆规格 Primary Cable	MM <sup>2</sup>	16	16	16	25	35	4	6
最大短路电流 Max. Short Circuit Current	KA	14	18	24	30	40	14.6	20
额定负载持续率 Rated Duty Cycle	%	20	20	20	20	20	50	50
次级电压 Secondary Empty Voltage	V	7.2	8.9	10.4	13	10.4	10	10
焊接气缸规格 Welding Cylinder Size	Φ*L	Φ50(32)*50	Φ80 (32)*50	Φ100*50	Φ100*50	Φ100*50	Φ25*25	Φ80*60
最大工作压力 Max. Working Pressure	N	1000	2510	3920	3920	3920	240	2500
气源管路中压缩空气压力 Compressed Air Pressure	MPa	0.6 ~ 0.7	0.6 ~ 0.7	0.6 ~ 0.7	0.6 ~ 0.7	0.6 ~ 0.7	0.6 ~ 0.7	0.6 ~ 0.7
冷却水消耗量 Cooling Water Consumption	L/MIN	6	6	8	12	12	*	*
压缩空气消耗量 Compressed Air Consumption	L/time	0.54	1.43	2.28	2.28	2.28	0.14	1.43
喉深 Throat Depth	MM	235	235	231	235	239	116.5	315
臂间距 Arm Gap	MM	230	230	260	260	258	75.5	195
电极尺寸 Electrode Size	MM	Φ25.4	Φ25.4	Φ25.4	Φ25.4	Φ25.4	Φ12	Φ25
外形尺寸 Dimensions	H(MM)	1461/901	1461/901	1478/954	1790/954	964	1225	1370
	L(MM)	831/672	831/672	962/707	869/707	707	550	550
	W(MM)	688/490	688/490	1004/503	860/524	542	670	710

注：DB: 中频台式 DR: 储能台式  
Note: DB:MFDC Bench DR: CD Bench

注：参数和机器图片仅供参考，在应用条件改变时，参数会有所不同。最终解释权归亨龙公司所有。  
Note: The parameters and equipment pictures are only for reference. When the application conditions changed, the parameters will be different. The final explanation right belongs to Heron company.

缝焊机  
Seam Welder

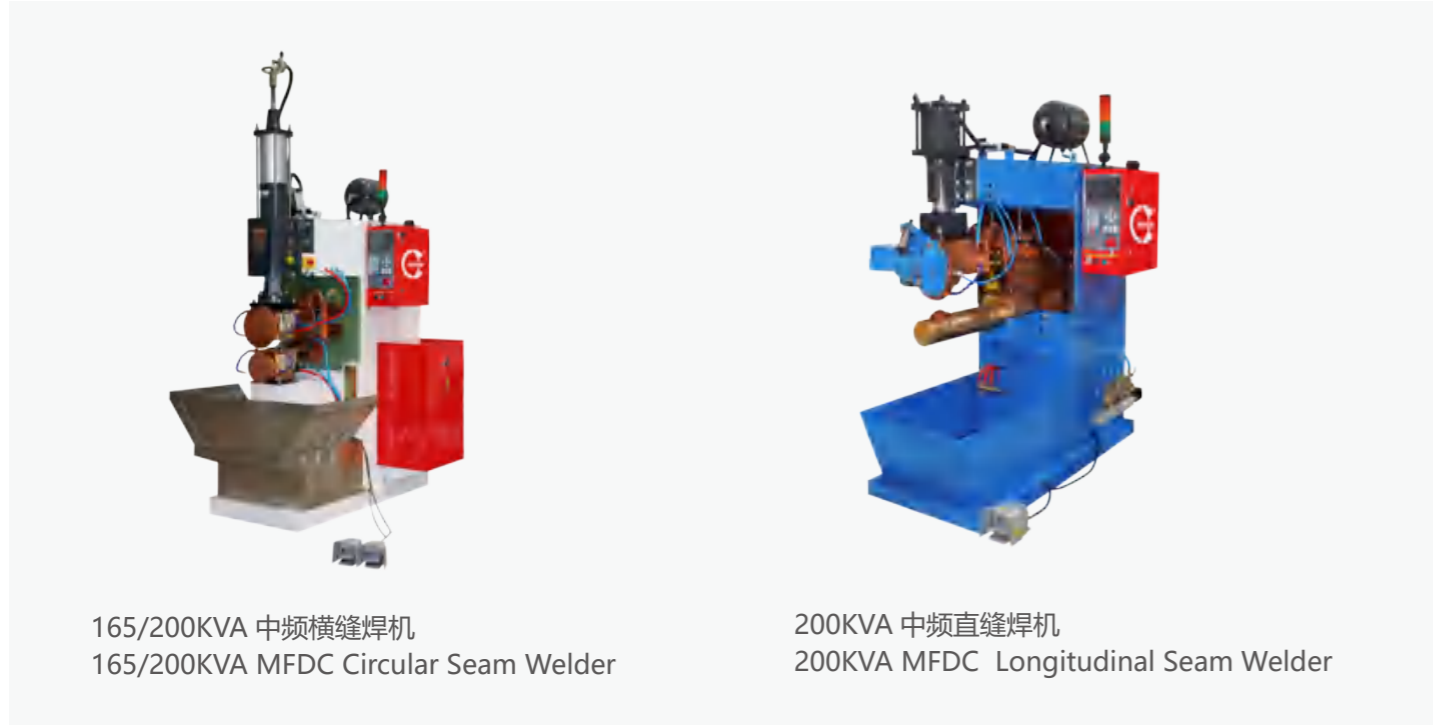

165/200KVA 中频横缝焊机  
165/200KVA MFDC Circular Seam Welder

200KVA 中频直缝焊机  
200KVA MFDC Longitudinal Seam Welder



50/80/100/150/200KVA 工频直缝焊机  
50/80/100/150/200KVA AC Longitudinal Seam Welder

技术参数  
Specifications

焊机型号 Model #		FB-200-C**	FB-200-L**	FN-50-L**	FN-80-L**	FN-100-L**	FN-150-L**
额定容量 Rated Capacity	KVA	MFDC 200	MFDC 200	AC 50	AC 80	AC 100	AC 150
外接电源 Power Supply	V/Φ/Hz	380/3/50	380/3/50	380/3/50	380/3/50	380/3/50	380/3/50
最大初级电流 Max. Primary Current	A	136	136	93	149	186	279
初级电缆规格 Primary Cable	MM <sup>2</sup>	50	50	50	50	120	120
最大短路电流 Max. Short Circuit Current	KA	35.3	35.3	14.5	19.43	20.4	27.5
额定负载持续率 Rated Duty Cycle	%	10	10	30	30	30	30
次级电压 Secondary Empty Voltage	V	10	10	5.4\4.5	5.8\6.7	6.7\5.8	8.6\8
焊接气缸规格 Welding Cylinder Size	Φ*L	Φ160*80	Φ160*80	Φ100*60	Φ125*80	Φ160*80	Φ160*80
最大工作压力 Max. Working Pressure	N	10000	10000	3900	6000	10000	10000
气源网路中压缩空气压力 Compressed Air Pressure	MPa	0.6 ~ 0.7	0.6 ~ 0.7	0.6 ~ 0.7	0.6 ~ 0.7	0.6 ~ 0.7	0.6 ~ 0.7
冷却水消耗量 Cooling Water Consumption	L/MIN	33	33	18	20	20	24
压缩空气消耗量 Compressed Air Consumption	L/time	5.84	5.84	2.28	3.56	5.84	5.84
喉深 Throat Depth	MM	535	1147	1147	1147	1147	1147
臂间距 Arm Gap	MM	247	115	115	115	115	115
电极尺寸 Electrode Size	MM	Φ330*10	Φ250*20	Φ250*20	Φ250*20	Φ250*20	Φ250*20
外形尺寸 Dimensions	H(MM)	2615	2368	2368	2368	2368	2368
	L(MM)	1878	2274	2274	2274	2274	2274
	W(MM)	1181	1263	1263	1263	1263	1263

注：C：横缝焊机      L：直缝焊机  
Note: C: Circular Seam Welder    L: Longitudinal Seam Welder

注：参数和机器图片仅供参考，在应用条件改变时，参数会有所不同。最终解释权归亨龙公司所有。  
Note: The parameters and equipment pictures are only for reference. When the application conditions changed, the parameters will be different. The final explanation right belongs to Heron company.

对焊机  
Butt Welder



150KVA 垂直加压式闪光对焊机  
150KVA Flash Butt Welder With Vertical Clamping Head  
ZUN-150-012-0002

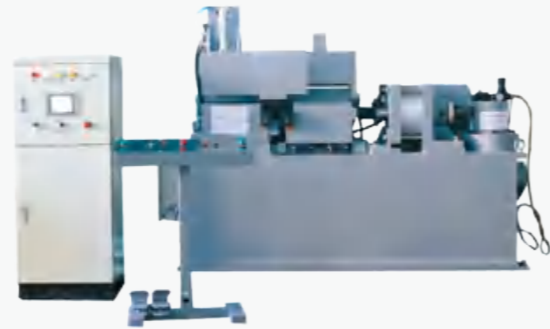

150KVA 杠杆加压式闪光对焊机  
150KVA flash Butt Welder With Hydraulic Toggle Clamping Head  
ZUN-150-012-0001



50/63KVA 垂直加压式对焊机  
50/63KVA Butt Welder With Vertical Clamping Head



25/35/50KVA 杠杆加压式对焊机  
25/35/50KVA Butt Welder With Air Toggle Clamping Head

技术参数  
Specifications

焊机型号 Model #		DN-50-U**0**	DN-63-U**0**	DN-25-U**1**	DN-35-U**1**	DN-50-U**1**
额定容量 Rated Capacity	KVA	50	63	25	35	50
外接电源 Power Supply	V/Φ/Hz	380V/1/50Hz		380V/1/50Hz		
最大初级电流 Max. Primary Current	A	94	117	47	65	94
初级电缆规格 Primary Cable	MM <sup>2</sup>	25	25	16	16	25
最大短路电流 Max. Short Circuit Current	KA	24	24.3	15.5	19	24
额定负载持续率 Rated Duty Cycle	%	50	50	50	50	50
次级电压 Secondary Empty Voltage	V	6.1	6.1	4.2	5.2	6.1
焊接气缸规格 Welding Cylinder Size	Φ*L	*	*	*	*	*
最大工作压力 Max. Working Pressure	N	*	*	*	*	*
气源管路中压缩空气压力 Compressed Air Pressure	MPa	0.6 ~ 0.7	0.6 ~ 0.7	0.6 ~ 0.7	0.6 ~ 0.7	0.6 ~ 0.7
冷却水消耗量 Cooling Water Consumption	L/MIN	8	8	6	6	8
压缩空气消耗量 Compressed Air Consumption	L/time	*	*	*	*	*
喉深 Throat Depth	MM	*	*	596	596	596
臂间距 Arm Gap	MM	*	*	198	198	198
电极尺寸 Electrode Size	MM	*	*	Φ31.75	Φ31.75	Φ31.75
外形尺寸 Dimensions	H(MM)	1280	1280	1396	1396	1396
	L(MM)	510	510	1391	1391	1391
	W(MM)	873	873	637	637	637

注：U\*\*0\*\*：垂直加压式  
U\*\*1\*\*：杠杆加压式

Note: U\*\*0\*\*： Vertical Clamping Head  
U\*\*1\*\*： Air Toggle Clamping Head

注：参数和机器图片仅供参考，在应用条件改变时，参数会有所不同。最终解释权归亨龙公司所有。  
Note: The parameters and equipment pictures are only for reference. When the application conditions changed, the parameters will be different. The final explanation right belongs to Heron company.

平台多关节焊机  
Platform Multi-joint Spot Welder



220KVA 多关节平台焊机  
220KVA Platform Multi-joint Spot Welder  
DB-220-15022



220KVA 多关节平台焊机  
220KVA Platform Multi-joint Spot Welder With Two Heads  
DB-220-15009

焊机型号 Model #		DB-220-15022	DB-220-15009
额定容量 Rated Capacity	KVA	220	220
外接电源 Power Supply	V/Φ/HZ	380/3/50	380/3/50
最大初级电流 Max. Primary Current	A	95	150
额定负载持续率 Rated Duty Cycle	%	20	20
最大短路电流 Max. Short Circuit Current	KA	20.5	40
最大工作压力 Max. Working Pressure	KN	250	250 (Φ80)、390 (Φ100)
次级电压 Secondary Empty Voltage	V	11.5	10.4
次级电压调节级数 Secondary Voltage Adjusted Level		1~99	1~99
电极平台尺寸 Electrode Platform Size	mm	1500*1000	1500*600
平台可调整高度 Adjustable Height Of the Platform	mm	150	100
焊接气缸行程 Stroke of cylinder	mm	Φ80*100	Φ80*80、Φ100*100
焊接能力 Welding Capaaity	mm	≤ 2	≤ 2
外形尺寸 Dimensions	H*L*W(MM)	2253x1500x2285	1900x1500x1270

中频手持式电焊钳  
MFDC Hand Hold Welding Gun

55KVA 中频手持式电焊钳  
55KVA MFDC Hand Hold Welding Gun



焊机型号 Model #		ZA0-F15009
额定容量 Rated Capacity	KVA	55
外接电源 Power Supply	V/Φ/HZ	380/3/50
最大初级电流 Max. Primary Current	A	90
最大短路电流 Max. Short Circuit Current	KA	17
外形尺寸 (手钳) Dimensions (Welding Gun)	L*W(MM)	195x58
外形尺寸 (控制器) Dimensions(Control)	H*L*W(MM)	828x610x1126

注：参数和机器图片仅供参考，在应用条件改变时，参数会有所不同。最终解释权归亨龙公司所有。  
Note: The parameters and equipment pictures are only for reference. When the application conditions changed, the parameters will be different. The final explanation right belongs to Heron company.

BTM 无铆钉铆接设备  
BTM Tog-L-Loc system



• 8T 铆接机  
8T Clinch Machine  
ZMY-008-1T1A00



• 15T 铆接机  
15T Clinch Machine  
ZMY-015-001-18007

焊机型号 Model #		ZMY-008-1T1A00	ZMY-015-001-18007
电源 Power Supply	V/Φ/HZ	220/1/50	380/3/50
最大气源压力 Max Air Pressure	Mpa	0.6	0.6
冲压力 Press Force	KN	74	130
总行程 Total Stroke	mm	100	100
增力行程 Power Stroke	mm	12	12
外形尺寸 (LxWxH) Dimension(LxWxH)	mm	800x960x2400	820x1060x2361

注：参数和机器图片仅供参考，在应用条件改变时，参数会有所不同。最终解释权归亨龙公司所有。  
Note: The parameters and equipment pictures are only for reference. When the application conditions changed, the parameters will be different. The final explanation right belongs to Heron company.

FSPR 平面自冲铆系统  
Flush Self-Piercing Riveting



ZMY-008-001-18002



ZM6-080-C22001

焊机型号 Model #		ZM6-080-C22001	ZMY-008-001-18002
电源 Power Supply	V/Φ/HZ	220/1/50	220/1/50
最大气源压力 Max Air Pressure	Mpa	0.5	0.6
冲压力 Press Force	KN	80	74
总行程 Total Stroke	mm	100	100
增力行程 Power Stroke	mm	10	12
外形尺寸 (LxWxH) Dimension(LxWxH)	mm	827x213x1526	800x960x2400

注：参数和机器图片仅供参考，在应用条件改变时，参数会有所不同。最终解释权归亨龙公司所有。  
Note: The parameters and equipment pictures are only for reference. When the application conditions changed, the parameters will be different. The final explanation right belongs to Heron company.



**汽车车身制造行业**  
Automotive Manufacturing Industry

在汽车制造业，我们拥有全系列的一体化悬挂焊机和机器人焊钳

Heron offers a comprehensive series of manual and robotic welding guns used in the automotive manufacturing industry



**汽车零部件制造行业**  
Auto-part Manufacturing Industry

在汽车零部件制造业，亨龙拥有全系列的汽车零部件焊接设备

Heron specializes in offering a variety of standard and custom resistance welding equipment used to make automotive components.

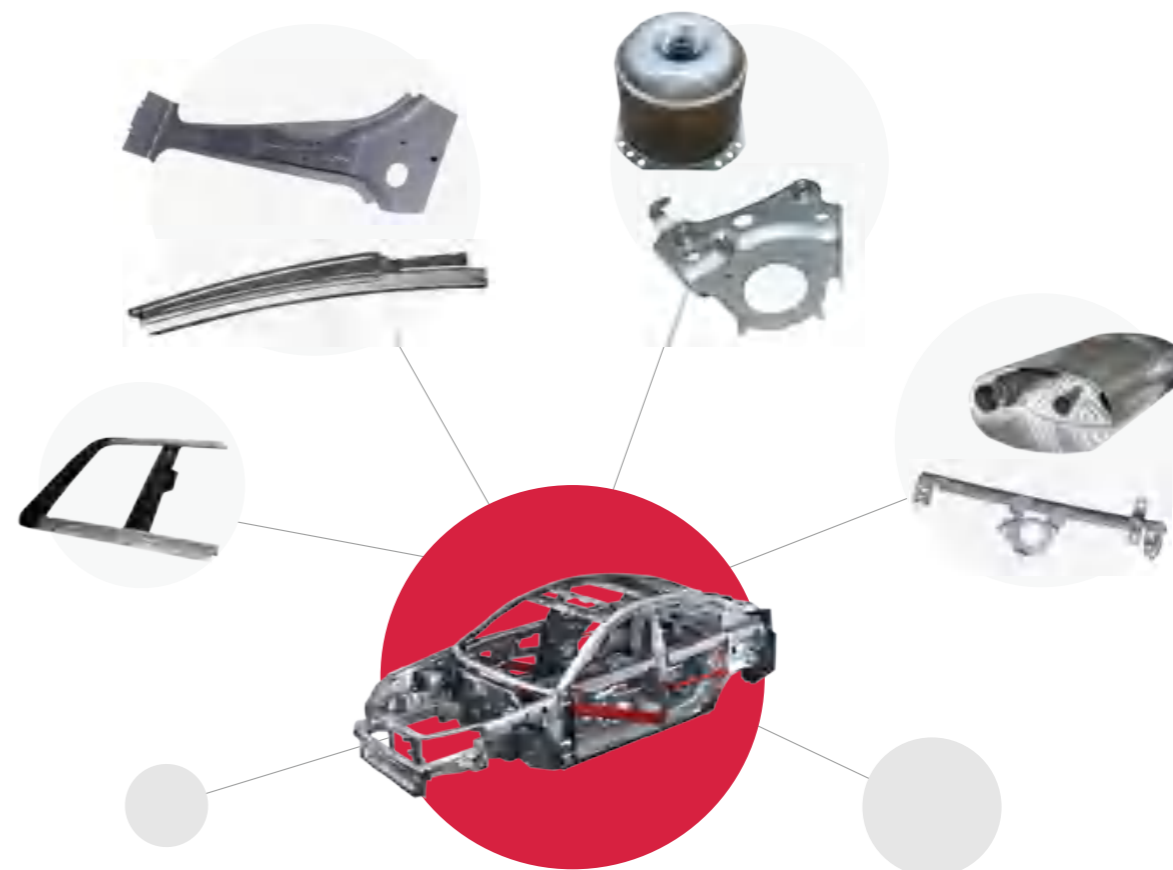

典型客户  
Typical Customers

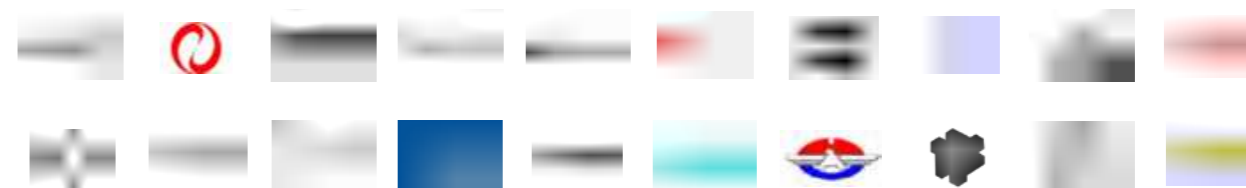

汽车门体系列设备  
Welding Equipment For Door Frame



660KVA 逆变缝焊机  
660KVA MFDC Seam Welder  
FB-660-C21002

门框中柱中频多点焊机  
MFDC Spot/Press Welder  
ZA0-FT1A06

汽车车身 A、B、C 柱系列设备  
Welding Equipment For Automobile A\B\C Pillar



20000J 双头储能焊机  
20000J Double Heads CD Spot/Press Welder

20000J 双头储能焊机  
20000J Double Heads CD Spot/Press Welder

汽车门体系列设备  
Welding Equipment For Door Frame



12000J 玻璃升降器三头储能焊机  
12000J Three Heads CD Press Welder For Automobile Window Track  
DR-12000-T1A00

12000J 玻璃升降器双头储能焊机  
12000J Double Heads CD Press Welder For Automobile Window Track  
DR-12000-T1A01

500KVA 三头导轨中频焊机  
560KVA Three Heads MFDC Press Welder For Automobile Window Track  
DB-2x250-17001

汽车消声器系列设备  
Welding Equipment For Car Muffler



250KVA 消声器中频自动缝焊机  
250KVA Single Wheel MFDC Seam Welder For The Muffler  
FB-250-L19001

100KVA 消声器焊机  
100KVA AC Welder For The Muffler  
DN-100-22003

220KVA 消声器中频焊机  
440KVA MFDC Welder For The Muffler  
DB-220-20041

## 气弹簧系列设备 Welding Equipment For Gas Spring

30KJ 气弹簧缸筒储能凸焊专机  
30KJ CD Press Welder For Gas Spring  
DR-30000-22003



220KVA 气弹簧缸筒中频凸焊专机  
220KVA MFDC Press Welder For Gas Spring  
DB-220-21015

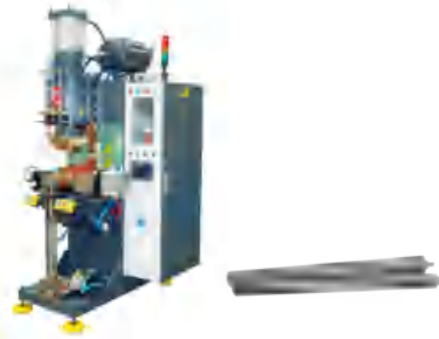

220KVA 气弹簧轴中频凸焊专机  
220KVA MFDC Press Welder For Gas Spring  
DB-220-21014



## 汽车、摩托车减震器系列设备 Welding Equipment For Auto & Motorcycle Shock Absorbers

200KVA 减震器逆变缝焊机  
200KVA Seam Welder For Shock Absorber  
FB-200-L20003



330KVA 减震器中频焊机  
330KVA MFDC Welder For Shock Absorber  
DB-330-19004

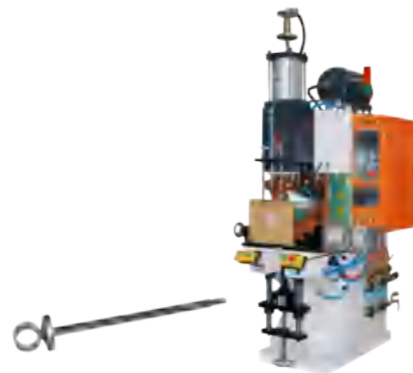

50KJ 减震器抱箍储能焊机  
50KJ CD Welder For Shock Absorber  
DB-330-19004



## 其它系列设备 Welding Equipment For Door Frame

60000J 刹车气室螺母储能焊机  
60000J CD Welder For Brake Air Chamber Nut  
DR-60000-20001



30KJ 调角器储能焊机  
30KJ CD Welder For Angle Adjuster  
DR-30000-20003



3x55KVA 汽缸垫片自动点焊机  
3x55KVA MFDC Welder For Cylinder Gasket  
DB-165-19014



## 凸焊工作站 Press Welding Workstation



S 系列  
S Series



M 系列  
M Series

## 凸焊工作站 Press Welding Workstation



L 系列  
L Series



L 系列  
L Series

冰箱压缩机制造行业

Refrigerator Compressor Manufacturing Industry

亨龙为冰箱压缩机制造提供了全系列的焊接设备

Heron supplies comprehensive production cells for refrigerator compressor manufacturers.



典型客户  
Typical Customers



标准化系列  
Standard Machines



440KVA 中频机脚（底脚板）焊机  
440KVA MFDC Welder For Base Legs



440KVA 压簧支柱中频焊机  
440KVA MFDC Welder For Pins



标准化系列  
Standard Machines



660KVA 密封接线柱中频焊机  
660KVA MFDC Welder For Terminal



440KVA 三管中频焊机  
440KVA MFDC Welder For Cooper Connector With Shell



220KVA 继电器支架中频焊机  
220KVA MFDC Welder For Relay Bracket



标准化系列  
Standard Machines



165/220KVA 接水盘卡座中频逆变焊机  
165/220KVA MFDC Welder For Bracket



110/165KVA 接地片中频焊机  
110/165KVA MFDC Welder For Grounding Piece

自动化专机  
Automated Special Machines



保护支架与接线端子自动焊机  
Automatic Welder For Terminal & Relay Bracket



下壳体机脚与销钉自动焊机  
Automatic Welder For Base Legs & Pins

自动化专机  
Automated Special Machines



220KVA 上盖支架自动焊机  
220KVA MFDC Automatic Welder For Bracket



220KVA 上盖支架自动焊机  
220KVA MFDC Automatic Welder For Bracket

自动化专机  
Automated Special Machines



冰箱压缩机三管生产线  
Production Line For Cooper Connector With Shell



冰箱压缩机下壳体自动生产线  
Fully Automatic Product Line For Refrigerator Shell Welding

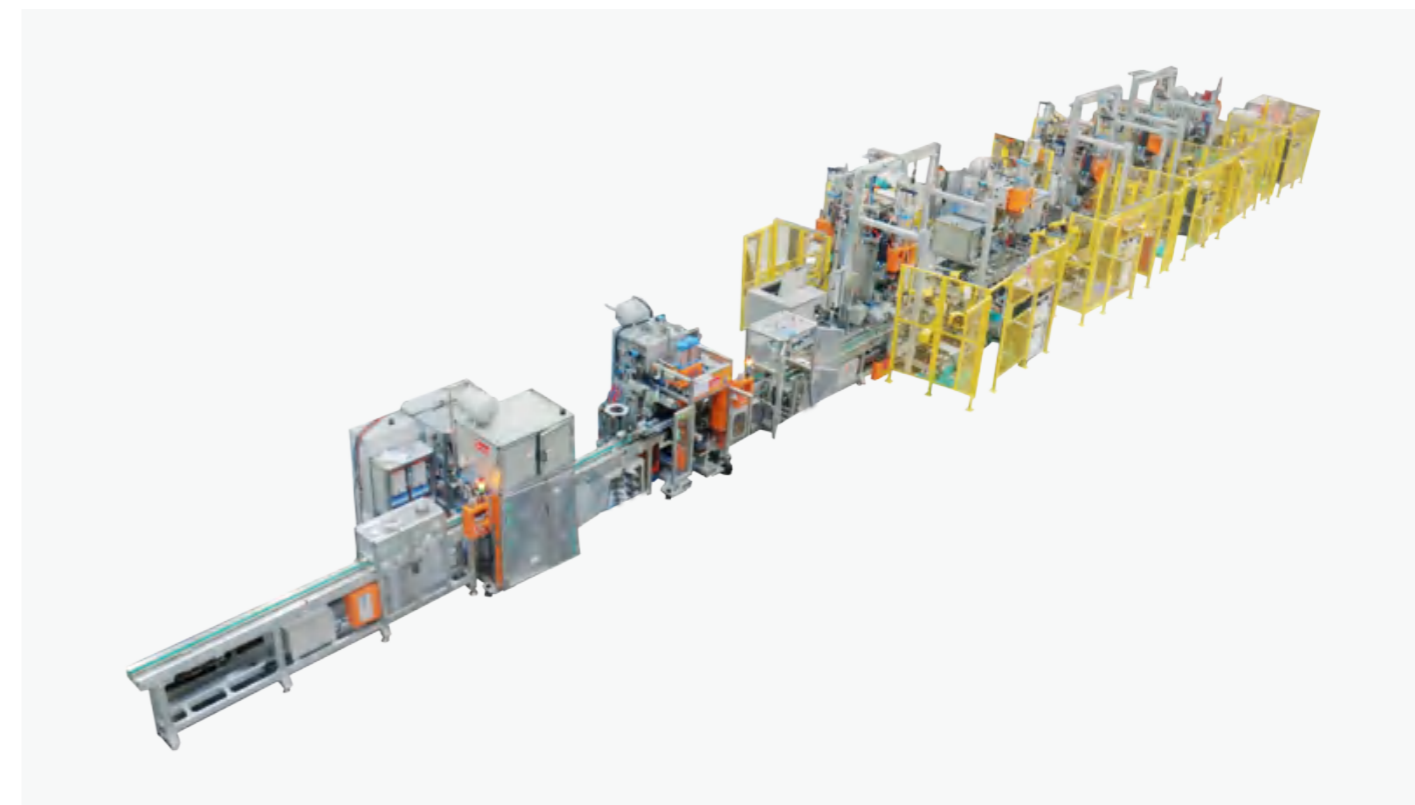
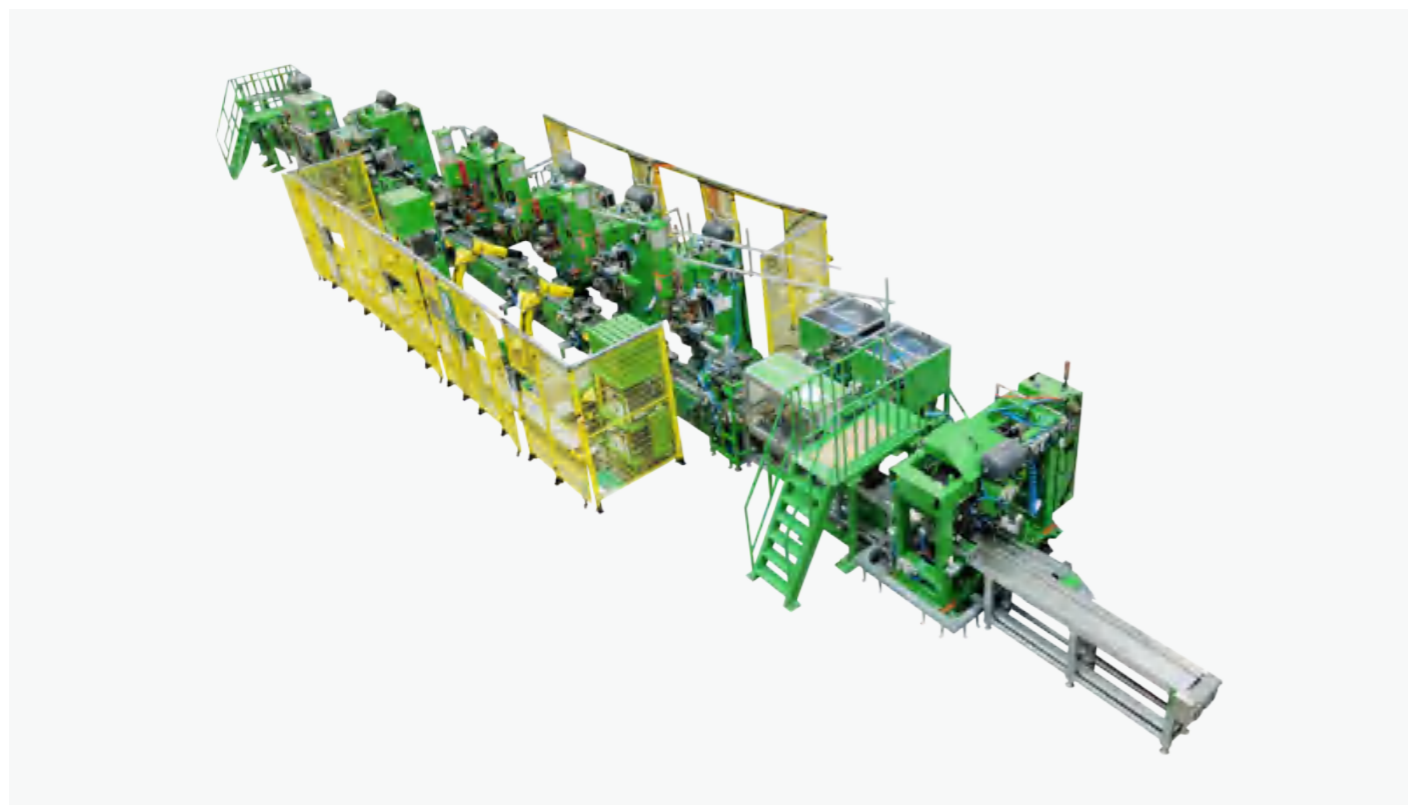

压簧支柱焊接  
Welding Of Pins



机脚焊接  
Welding Of Base Legs



密封接线柱焊接  
Welding Of Terminal

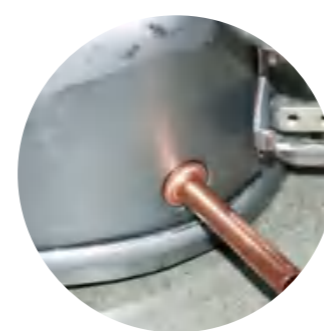

工艺管焊接  
Welding Of Copper Tube



排气管吸气管焊接  
Welding Of Copper Tube



保护支架管焊接  
Welding Of Relay Bracket

空调压缩机制造行业

Air Conditioning Compressor Manufacturing Industry

亨龙为空调压缩机制造提供了全系列的焊接设备

Heron supplies comprehensive production cells for Air conditioning compressor manufacturers.



典型客户  
Typical Customers



标准化系列  
Standard Machines



35000J 接线端子储能焊机  
35000J CD Welder For Terminal



165KVA 螺栓中频焊机  
165KVA MFDC Welder For Bolt Welded To Cover



440KVA 上盖排气管中频焊机  
440KVA MFDC Welder For Suction Pipe



标准化系列  
Standard Machines



660KVA 储液器吸气、排气管中频焊机  
660KVA MFDC Welder For Oil Tank Bend Pipe



150000J 储液器上下盖中压储能焊机  
150000J CD Welder For Oil Tank



标准化系列  
Standard Machines



165KVA 支架中频焊机  
165KVA MFDC Welder For Bracket



20000J 支架螺母储能焊机  
20000J CD Welder For Bracket Nut



主壳体三点弧焊机  
Main Housing Three-Point Arc Welding Machine



标准化系列  
Standard Machines



220KVA 三头支脚中频凸焊机  
220KVA MFDC Welder For Base Legs



660KVA 中频导管焊机  
660KVA MFDC Welder For Suction Pipe

空调压缩机壳体生产线  
Air Conditioner Compressor Casing Production Line



空调压缩机铜管和支架全自动双工位机器人工作站  
Press Welding Robot Workstation For Bracket & Suck Pipe

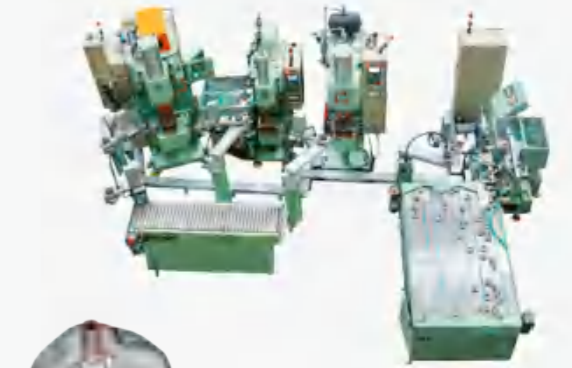

压缩上壳盖焊接智能自动生产线  
Automatic Welder For Cover Vent Pipe And Bolt



储液器上下盖生产线  
Oil Tank Top And Bottom Cap Production Line



低压电器制造行业

Low-Voltage Electrical Manufacturing Industry

在低压电气行业，亨龙开发了全系列的手工及自动化设备，实现了银铜直接焊接的工艺

In the low-voltage electrical manufacturing field, Heron has developed a whole series of manual and automatic equipment and developed directly welding Cu to Ag by resistance welder.



典型客户  
Typical Customers



框架断路器生产线  
Frame Breaker Production Line



框架断路器系列设备  
Welding Equipment For Frame Breaker



2500KVA 框架断路器导电母排中频焊机  
2500KVA MFDC Welder For Frame Breaker Bus Bar



动触头组件自动焊机  
Automatic Welder For Mobile Contact Assembly

塑壳断路器系列设备

Welding Equipment For Moulded Case Circuit Breaker



动触头系统焊接自动线  
Automatic Production Line For Welding Of Dynamic Contact System

塑壳断路器系列设备

Welding Equipment For Moulded Case Circuit Breaker



静触头八工位自动焊接专机  
Automatic Welder For Static Contact With 8 Stations

静触头四工位自动焊接专机  
Automatic Welder For Mobile Contact With 4 Stations

塑壳断路器系列设备

Welding Equipment For Moulded Case Circuit Breaker



动触头系统焊接自动线  
Automatic Production Line For Welding Of Dynamic Contact System

母线系列

Welding And Clinching Equipment For Busbar Series

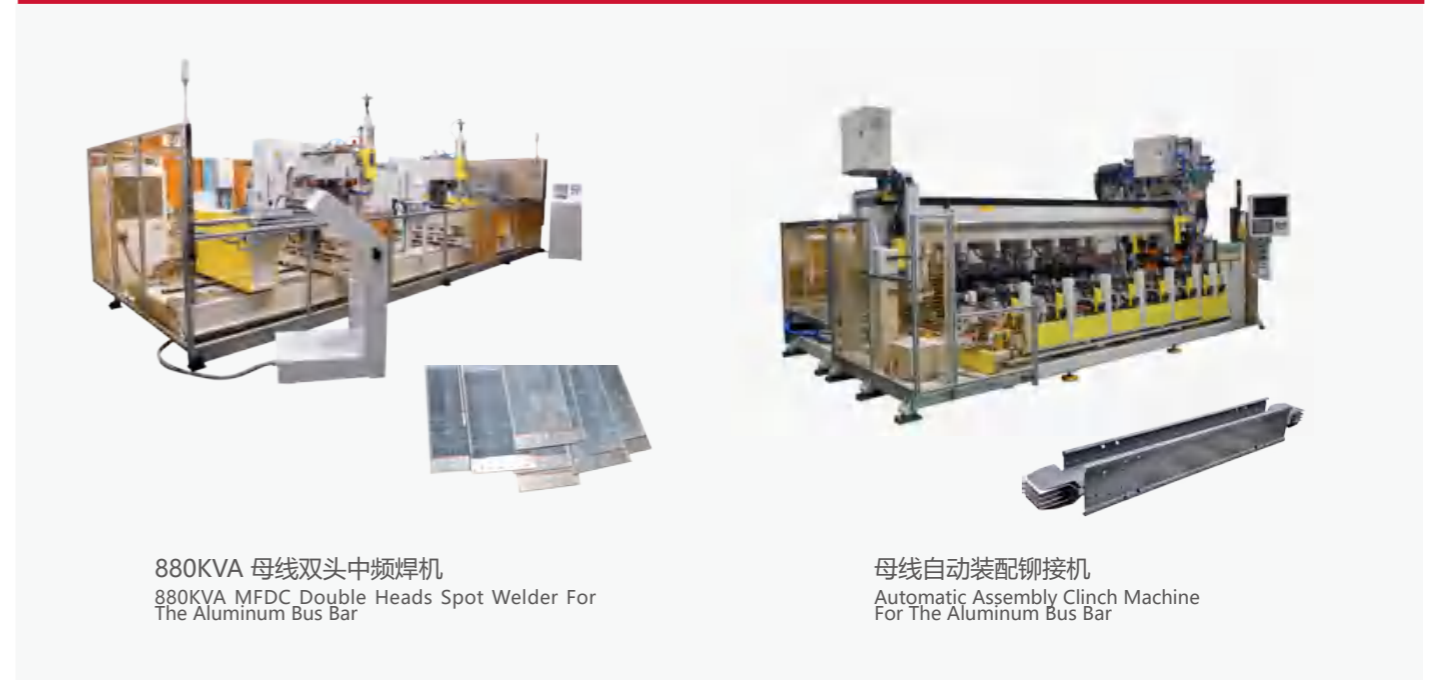

880KVA 母线双头中频焊机  
880KVA MFDC Double Heads Spot Welder For The Aluminum Bus Bar

母线自动装配铆接机  
Automatic Assembly Clinch Machine For The Aluminum Bus Bar

插座插针系列设备

Welding Equipment For Socket & Plug



55KVA 自动焊接专机  
55KVA MFDC Welder For Plug



55KVA 排插支架自动焊机  
55KVA MFDC Welder For Socket

全系列多股线系列设备

Welding Equipment For Braided Copper



50/80KVA 多股铜编织线自动焊接剪切机  
50/80KVA AC Customized Welding And Cutting Machine For Braided Copper



55/110/165/220/330/440/660/880KVA 铜编织线焊接剪切专机  
55/110/165/220/330/440/660/880KVA MFDC Customized Welding And Cutting Machine For Braided Copper

微断系列设备

Welding Equipment For Micro Circuit Breaker

165KVA 中频台式焊机  
165KVA MFDC Bench Welder With Table

DB-165-20025



55KVA 中频台式焊机  
55KVA MFDC Bench Welder With Table

DB-55-15106



25/55/110/165/220KVA 中频台式焊机  
25/55/110/165/220KVA MFDC Bench Welder With Table

DB-25/55/110/165/220



55KVA 中频台式焊机  
55KVA MFDC Bench Welder With Table

DB-55-13107



磁脱扣八工位自动焊机  
Automatic Welder For Magnetic Disconnect With 8 Stations

DB-110-14009



110KVA 动触头自动化焊机  
110KVA Full Automatic Welder For The Silver Tip

DB-110-14007



55KVA 静触头六工位自动焊机  
55KVA MFDC Resistance Welder For The Static Contact With 6 Stations

DB-55-13010



55KVA 连接片六工位自动焊机  
55KVA MFDC Resistance Welder For Connection piece With 6 Stations

DB-55-13009



家电制造行业  
Home Appliance Manufacturing Industry

我们为家电行业提供了大量的焊接装备  
We have supplied welding equipment for home appliance manufacturing field.



典型客户  
Typical Customers



微波炉系列设备  
Welding And Clinching Equipment For Microwave



20000J 微波炉箱体双头储能焊机  
20000J CD Welder For Microwave With Two Head



10000J 微波炉箱体单头储能焊机  
10000J CD Welder For Microwave With One Head



抽油烟机系列设备  
Welding And Clinching Equipment For Range Hood



75T 电器外壳铆接机  
75T Clinch Machine For Electric Cover

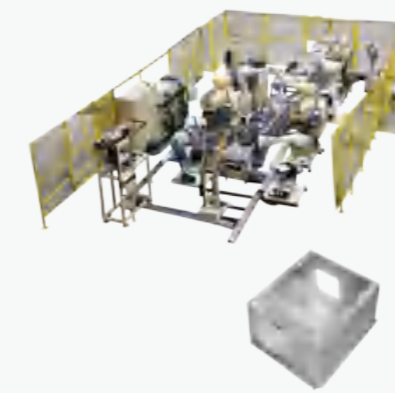

抽油烟机箱体铆接生产线  
Automatic Welder For Range Hood



抽油烟机箱体铆接生产线  
Automatic Clinch Machine For Range Hood

电热水器系列设备

Welding Equipment For Electric Water Heater

440KVA 进水管双头中频焊机  
440KVA MFDC Welder For Water Inlet Pipe With Two Heads

DB-440-T1A04



8000J 吊架焊接专机  
8000J CD Welder For Hanger

DR-8000-T1A02



15000J 吊挂焊接专机  
15000J CD Welder For Hanger

DR-15000-T1A01



35000J 圆法兰焊接专机  
35000J CD Welder For Flange

DR-35000-17003



880KVA 水管排污管电阻焊机  
880KVA MFDC Welder For Water Pipe

DB-880-19008



150KJ 商用热水器水嘴电容储能凸焊机  
150KJ CD Projection Welder For Commercial Water Heater Outlet

DR-150000-20003



燃气热水器系列设备

Welding Equipment For Gas Water Heater

2\*8000J 双头挂架储能焊机  
2\*8000J Double Head CD Welder For Hanger

DR-16000-20001



15000J 挡板储能焊机  
15000J CD Welder For Baffle

DR-15000-20007



燃气热水器系列设备

Welding Equipment For Gas Water Heater

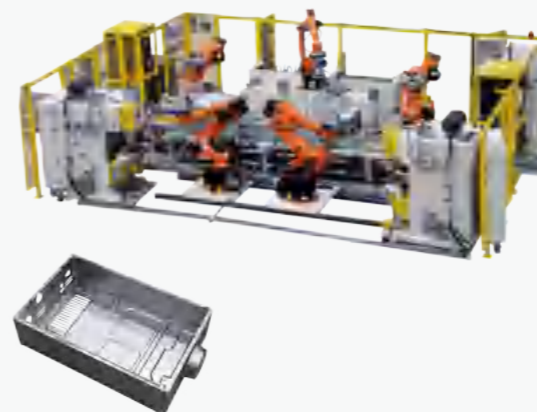

燃气热水器底盖组焊一体化全自动生产线  
Automatic Welder For Shell And Base Plate



全自动燃烧器焊接切边专机  
Automatic Welder For The Burner

烤炉系列焊接设备

Welding And Clinching Equipment For Oven

微蒸烤内胆生产线  
Microwave steaming baking inner tank production line

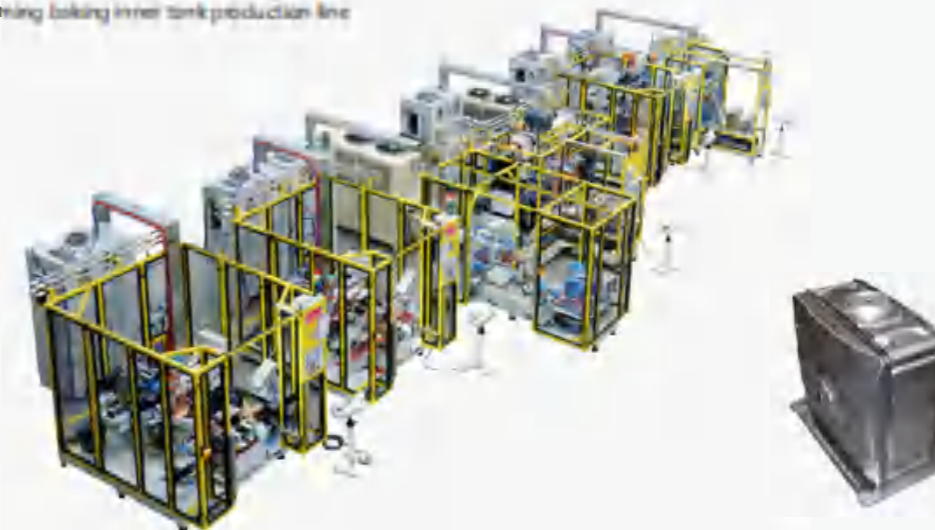

洗碗机系列设备

Welding And Clinching Equipment For Dishwasher

165KVA 洗碗机内胆直缝焊机  
165KVA Seam Welder For Dishwasher Liner

FB-165-C18002

165KVA 洗碗机内胆与底板缝焊机  
165KVA Seam Welder For Dishwasher Liner

FB-165-C18001

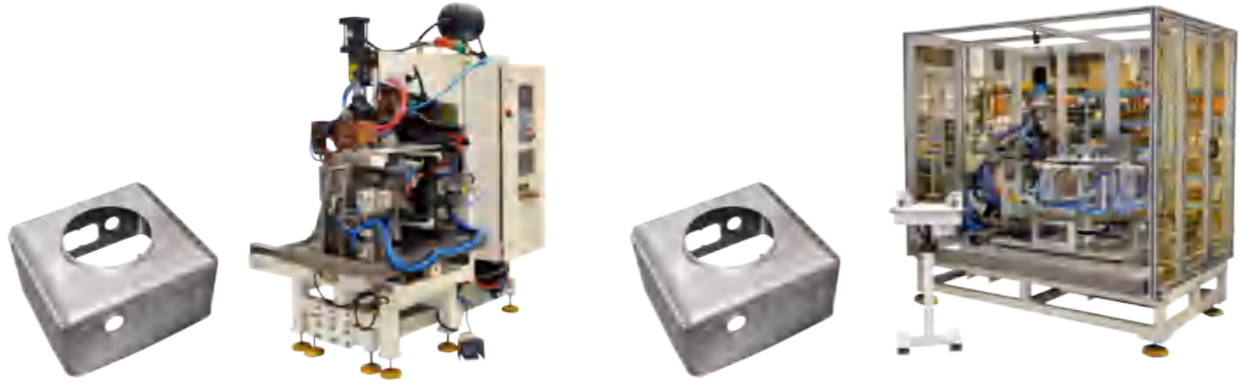

25T 洗碗机加强筋组件铆接机  
25T Clinch Machine For Dishwasher Strengthening Assembly

ZMY-025-001-17002

8T 洗碗机顶板与水管支架铆接机  
8T Clinch Machine For Dishwasher Top Plate And Water Pipe Bracket

ZMY-008-001-17002

30T 洗碗机加强筋与铰链板铆接机  
30T Clinch Machine For Dishwasher Strengthening Rib And Hinge

ZMY-030-001-17001



50T 洗碗机内胆与密封框铆接机  
50T Clinch Machine For Dishwasher Liner And Sealed Frame

ZMY-050-001-17003

35T 洗碗机内胆与加强筋组件铆接机  
35T Clinch Machine For Dishwasher Liner And Strengthening Assembly

ZMY-035-001-17002

中板自动铆接折弯机  
Bending & Clinch Machine For Dishwasher

ZMY-015-001-17002



洗碗机系列设备

Welding And Clinching Equipment For Dishwasher

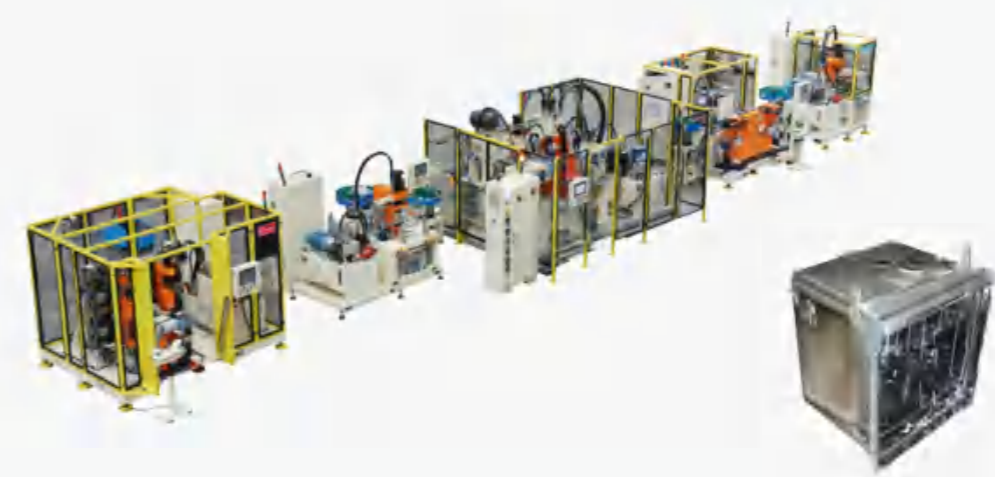

洗碗机箱体生产线  
Dishwasher Case Production Line

洗衣机系列设备

Clinching Equipment For Wash Machine

波轮洗衣机箱体铆接线  
Clinch Line For Pulsator Washing Machine

滚筒洗衣机箱体铆接线  
Clinch Line For Drum Washing Machine

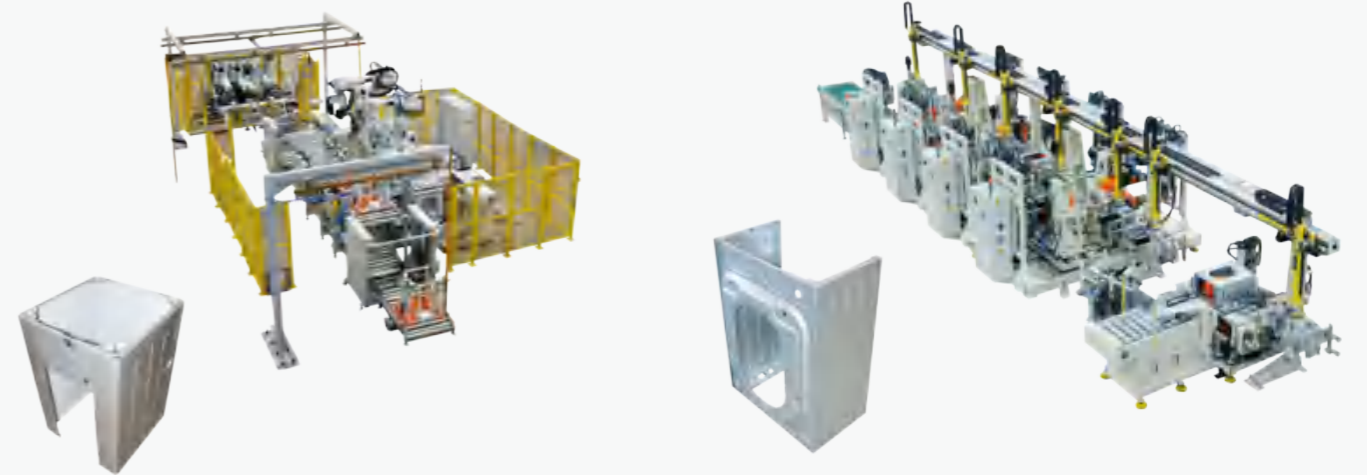

### 洗衣机系列设备

Clinching Equipment For Wash Machine

45T 洗衣机底板铆接机  
45T Clinch Machine For Wash Machine Body Assembly

ZMY-045-001-16001

120T 洗衣机底板铆接机  
120T Clinch Machine For Wash Machine Body Assembly

ZMY-120-001-16001



15T 洗衣机面板铆接机  
15T Clinch Machine For Washing Machine Panel

ZMY-015-001-19001

30T 洗衣机面板铆接机  
30T Clinch Machine For Washing Machine Panel

ZMY-030-001-19001

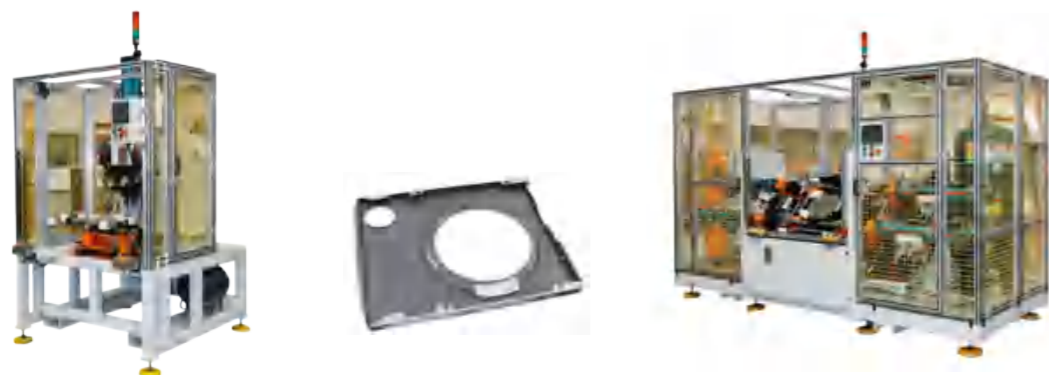

### 油汀系列设备

Welding Equipment For Oil Heater

440KVA 油汀散热片中频缝焊机  
440KVA MFDC Seam Welder For Oil Heater

FB-440-C18001

220KVA 油汀散热片中频组焊机  
220KVA MFDC Welder For Oil Heater

DB-220-18035



## 电机制造行业

### Motor Manufacturing Industry

亨龙产品广泛应用于汽车启动电机、发电机，以及其他电机制造业

Heron specializes in welding equipment that is used in applications ranging from starters to generators.

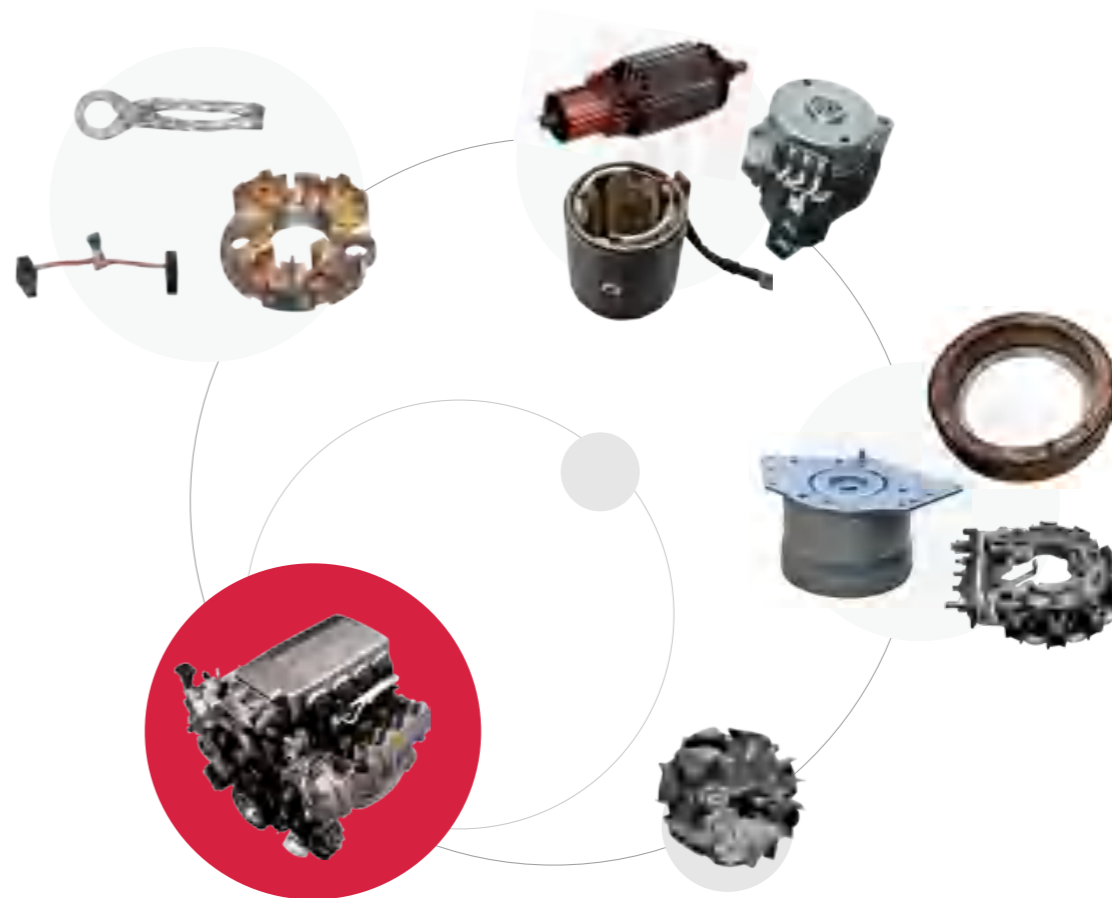

### 典型客户

Typical Customers



启动电机定子焊接  
Starter Motor Stator Welding



碳刷架焊接  
Carbon Brush Holder Welding



驱动电机焊接  
Drive Motor Welding

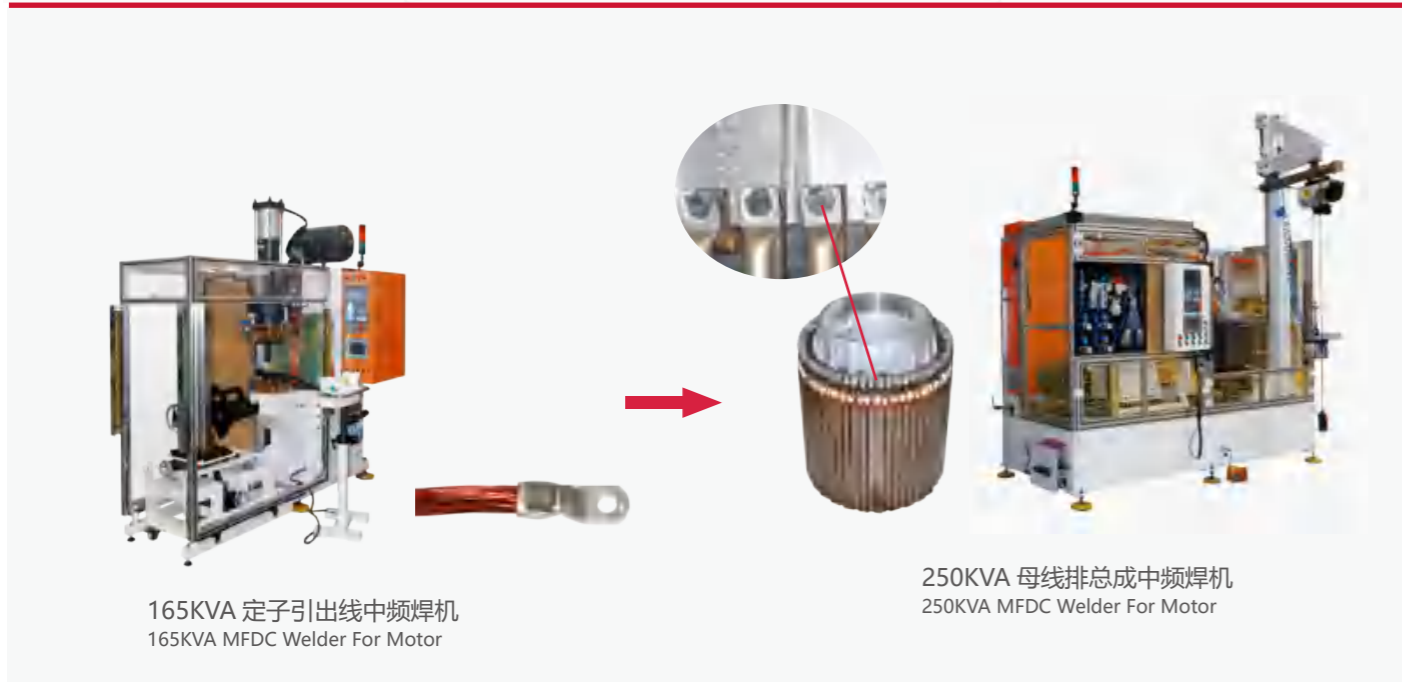

电机外壳焊接  
Motor Shell Welding



### 发电机定子系列设备

Welding Equipment For Motor Stator

10000J 汽车电机风扇叶与转子储能焊机  
10000J CD Welder For Rotor Fan

DR-10000-13001

2x440KVA 马达转子叶片中频焊机  
2x440KVA MFDC Welder For Rotor Fan

DB-880-20001

440KVA 马达转子叶片中频焊机  
440KVA MFDC Welder For Rotor Fan

DB-440-20002



55KVA 马达定子中频焊机  
55KVA MFDC Welder For Motor Stator

DB-55-13005

55KVA 汽车马达整流桥电阻焊机  
55KVA MFDC Welder For Rectifier Bridge

DB-55-15001



### 启动电机转子系列设备

Welding Equipment For Armature

110KVA 起动机转子双头逆变钎焊机  
110KVA MFDC Double Heads Welder For Armature

DB-110-QT1A00

55KVA 伺服加压马达转子焊机  
55KVA Servo MFDC Welder For Armaturer

DB-55-QT1A00



### 新能源驱动电机系列设备

Welding Equipment For EV Drive Motor



220KVA 接线端子和漆包线焊接机  
220KVA Terminal Block And Enamelled Wire Welding Machine For EV Drive Motor

250KVA 带上下运动机头接线端子和漆包线焊接机  
250KVA Terminal Block And Enamelled Wire Welding Machine With Moving Head For EV Drive Motor

220KVA 接线端子和漆包线工作站  
220KVA Terminal Block And Enamelled Wire Welding Station For EV Drive Motor

### 驱动电机系列设备

Welding Equipment For Motor

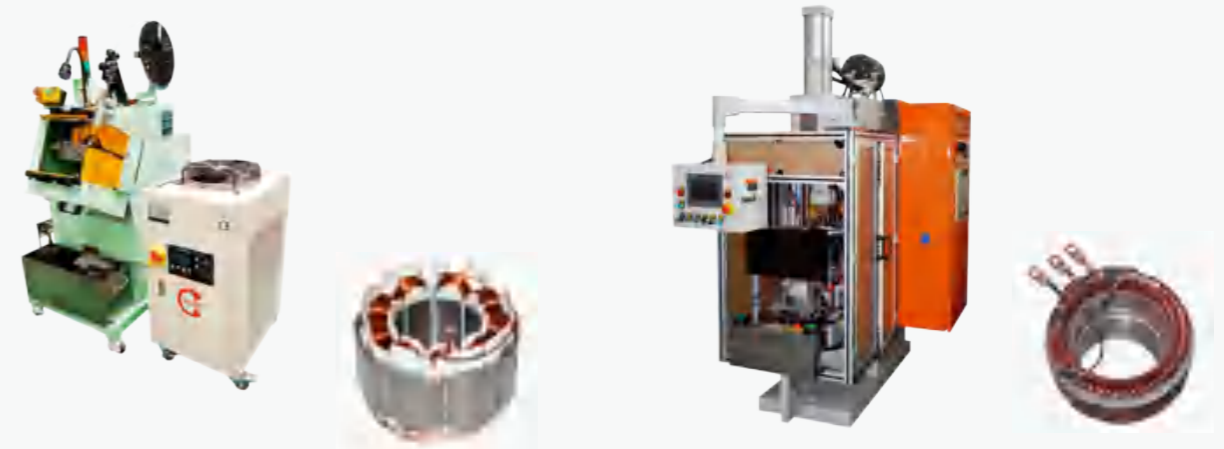

线束 +C 型套焊接专机  
Enamelled Wire Harness + C Type Sleeve Welder

110KVA 扁铜线中频焊机  
110KVA MFDC Welder For Motor

五金制造行业  
Hardware Manufacturing Industry

我们为五金行业提供了大量的焊接装备  
We have supplied welding equipment for hardware manufacturing field.

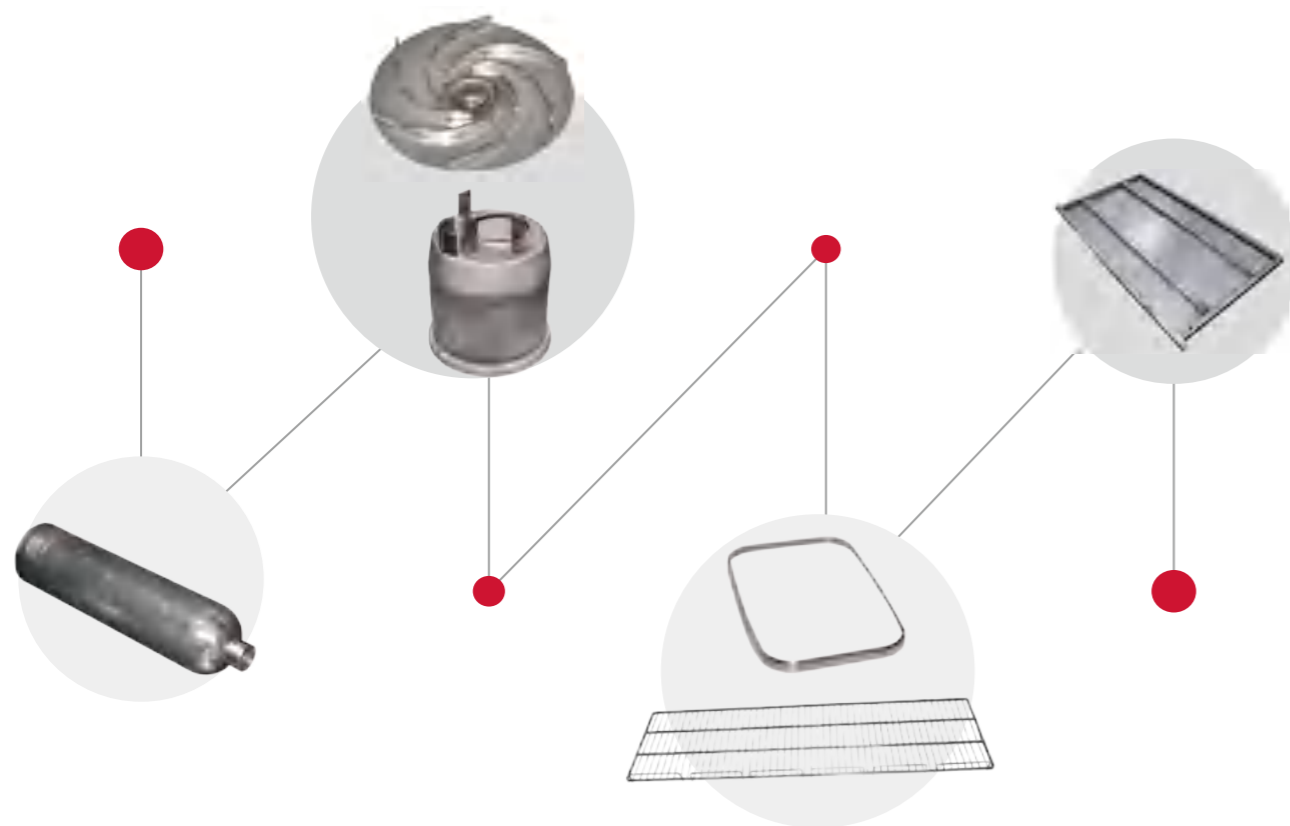

典型客户  
Typical Customers



水泵系列设备  
Welding Equipment For Water Pump



60000J 水泵叶片八工位中压储能焊机  
60000J CD Welder For Water Pump Vane With 8 Station



60000J 水泵出水口中压储能焊机  
60000J Medium Voltage Capacitor Discharge Welder For The Water Pump Outlet

消防瓶系列设备  
Welding Equipment For Firefighting Bottle



220KVA 消防瓶中频缝焊机  
220KVA MFDC Seam Welder For Firefighting Bottle



45000J 消防瓶中压电容储能点焊机  
45000J CD Welder For Firefighting Bottle

**超市货架层板加强筋系列设备**

Welding And Clinch Equipment For Supermarket Shelf



440KVA 货架顶底板长边加强筋中频焊机  
440KVA MFDC Multi Spot Welder For Supermarket Shelf



货架顶底板中频自动焊机  
MFDC Automatic Welder For Supermarket Shelf



26 点超市货架中频焊机  
MFDC Multi Spot Welder With 26 Heads  
For Stiffener For Supermarket Shelf



440KVA 货架顶底板短边加强筋中频焊机  
440KVA MFDC Multi Spot Welder For Supermarket Shelf

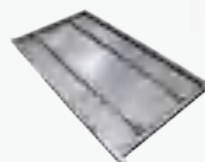

**铁丝网系列设备**

Welding Equipment For Wire Frame



2x50KVA 冰箱网工频焊机  
2x50KVA AC Welder For Refrigerator  
Wire Frame



2x100KVA 冰箱网工频焊机  
2x100KVA AC Welder For Refrigerator  
Wire Frame



220KVA 冰箱网中频焊机  
220KVA MFDC Welder For Refrigerator  
Wire Frame



**建材制造行业专用设备**

Building Material Manufacturing Industry

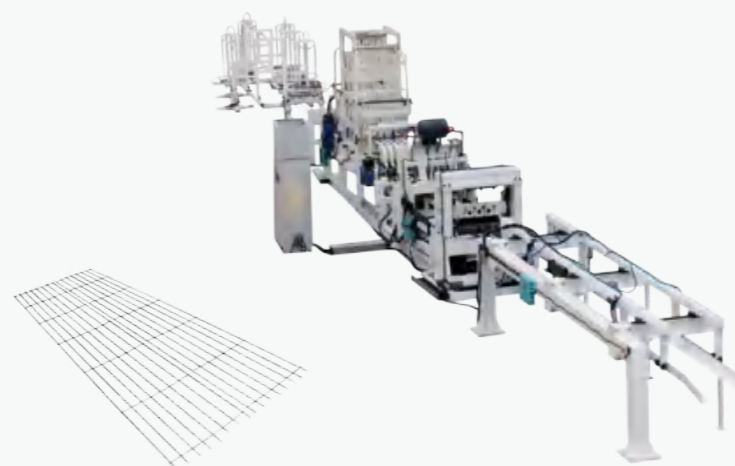

200KVA 加气墙体骨架铁线网自动焊机  
200KVA Automatic Multi Spot Welder With Wire  
Feeder For Preformed Wall Frame

**其它行业**

Other Manufacturing Industry



880KVA 中频焊机  
880KVA MFDC Press Welder

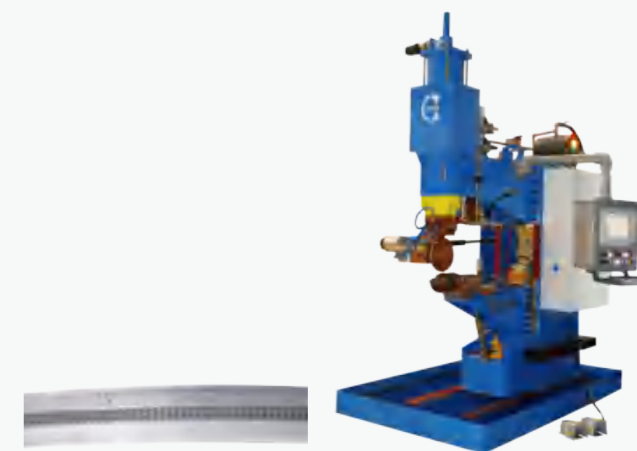

400KVA 中频滚缝焊机  
400KVA MFDC Seam Welder